

A-A

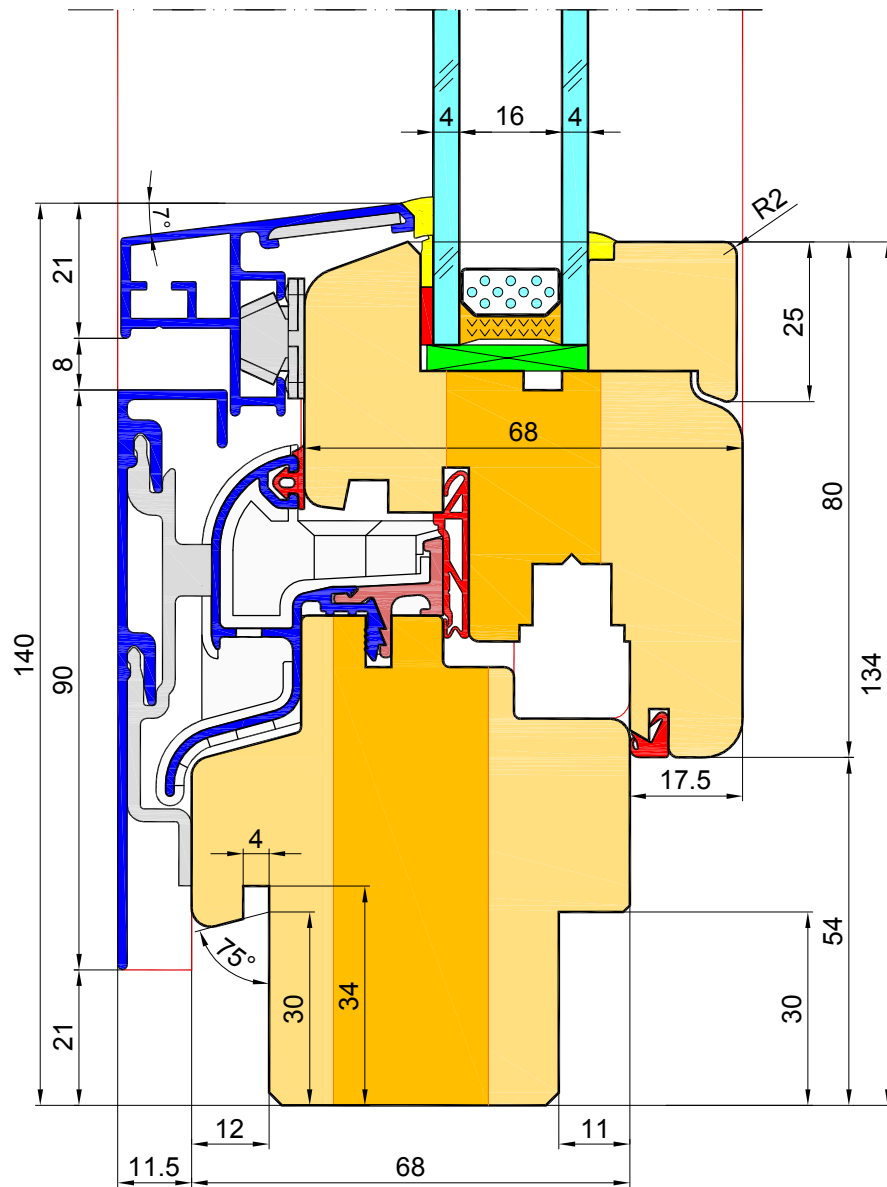

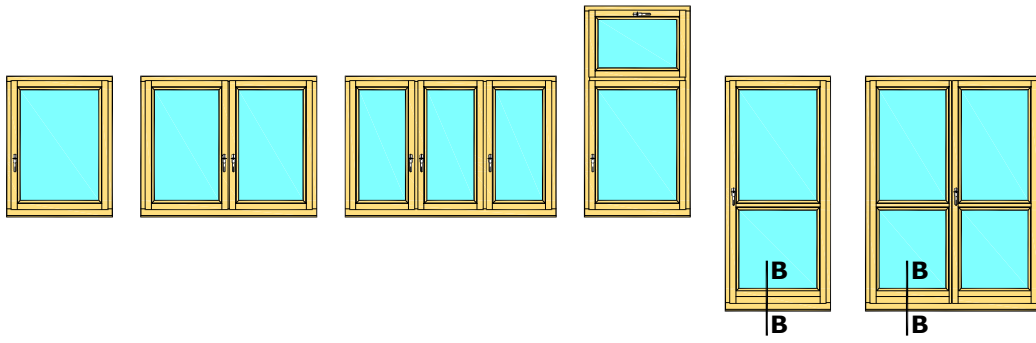

B-B

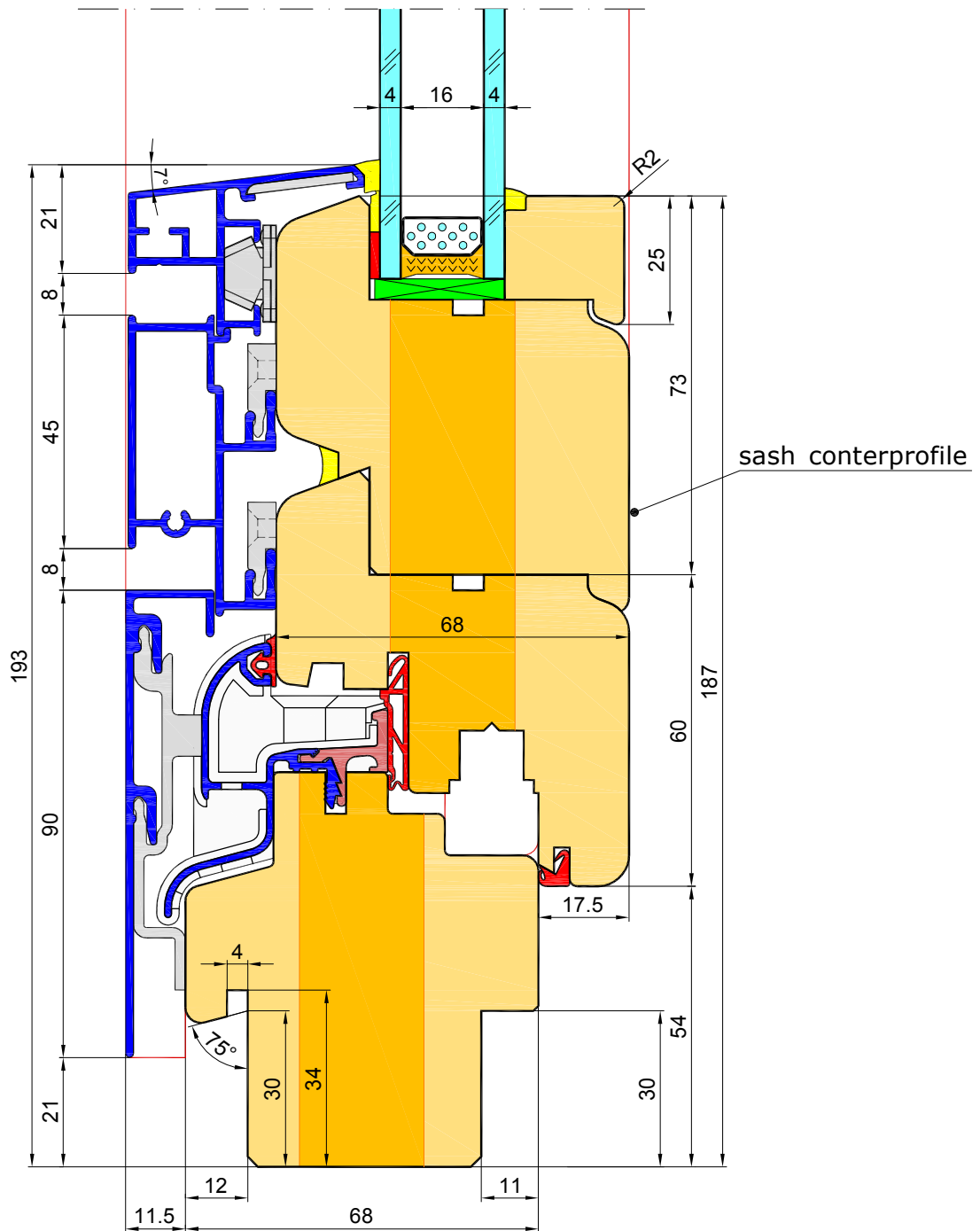

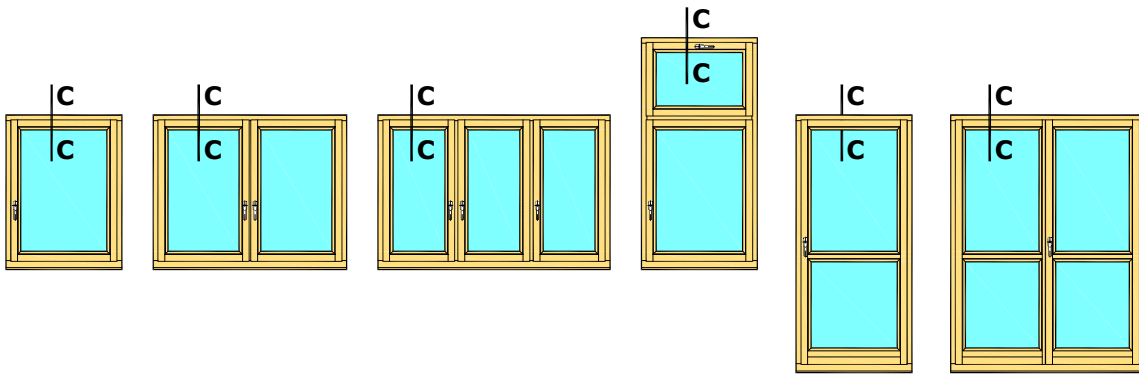

C-C

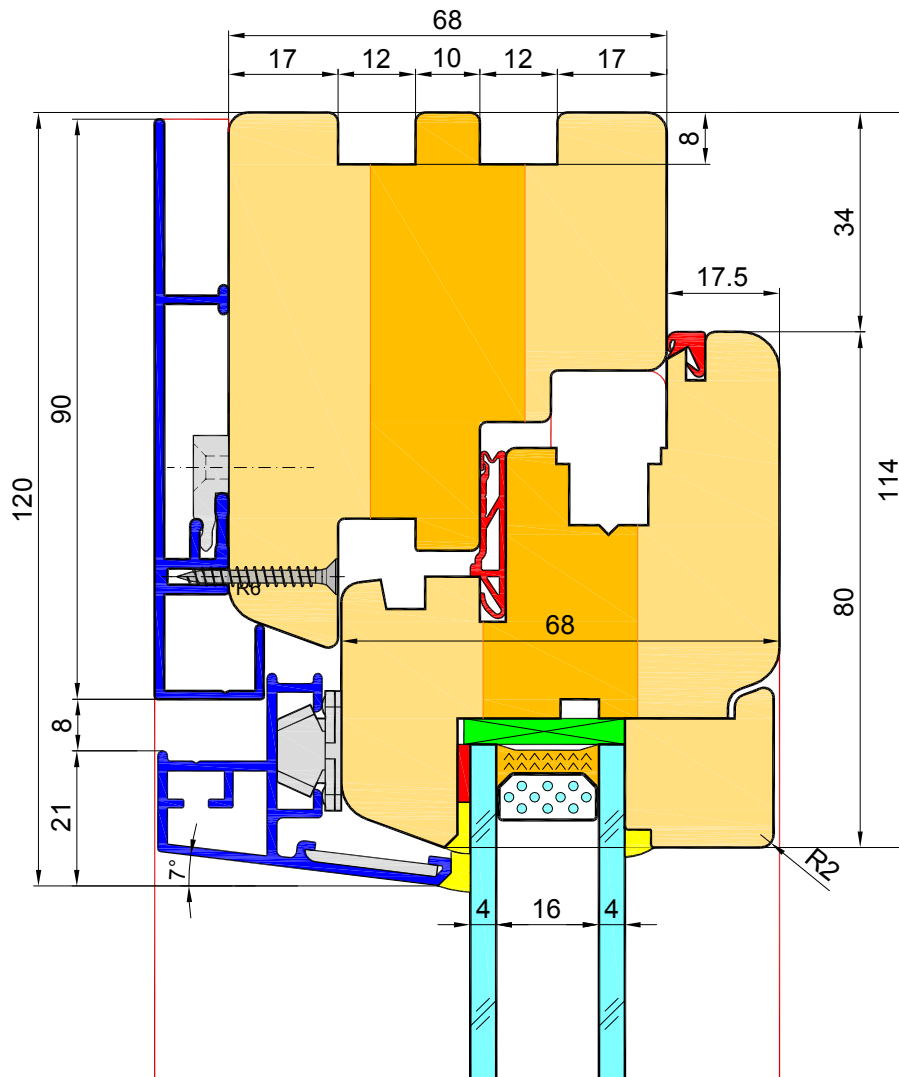

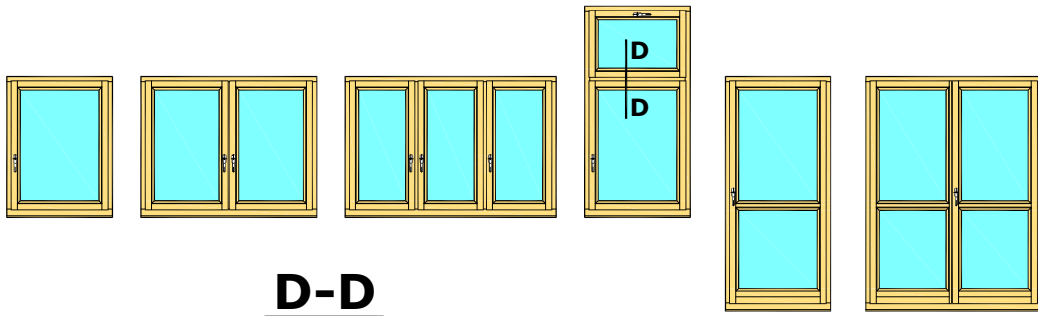

D-D

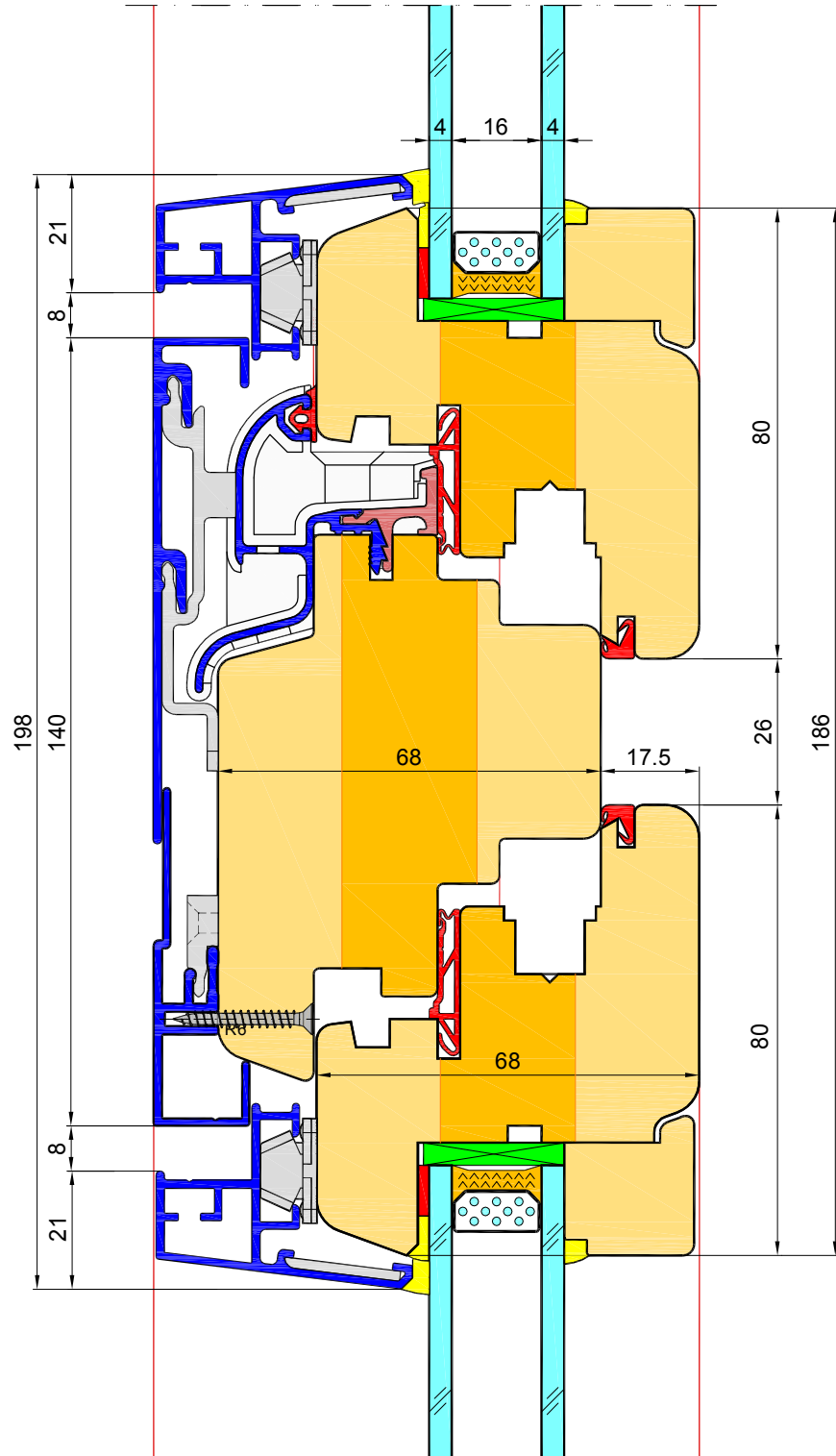

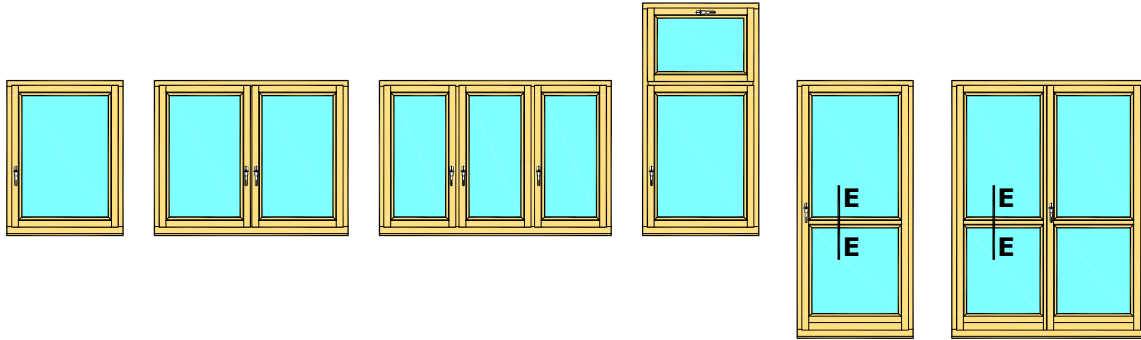

E-E

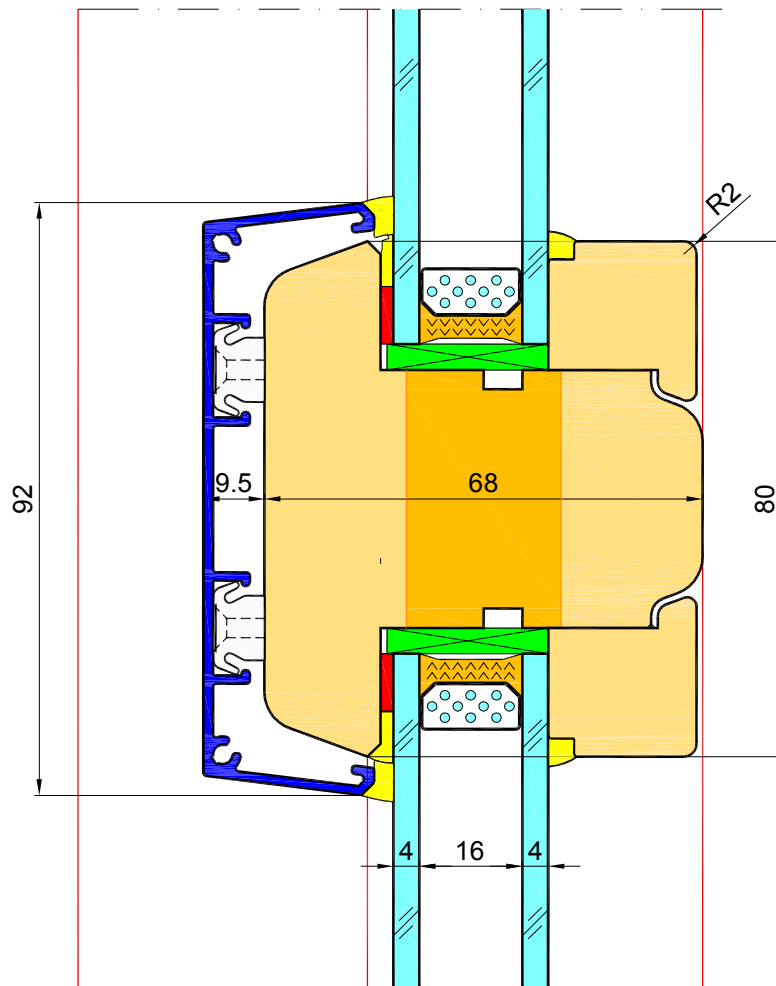

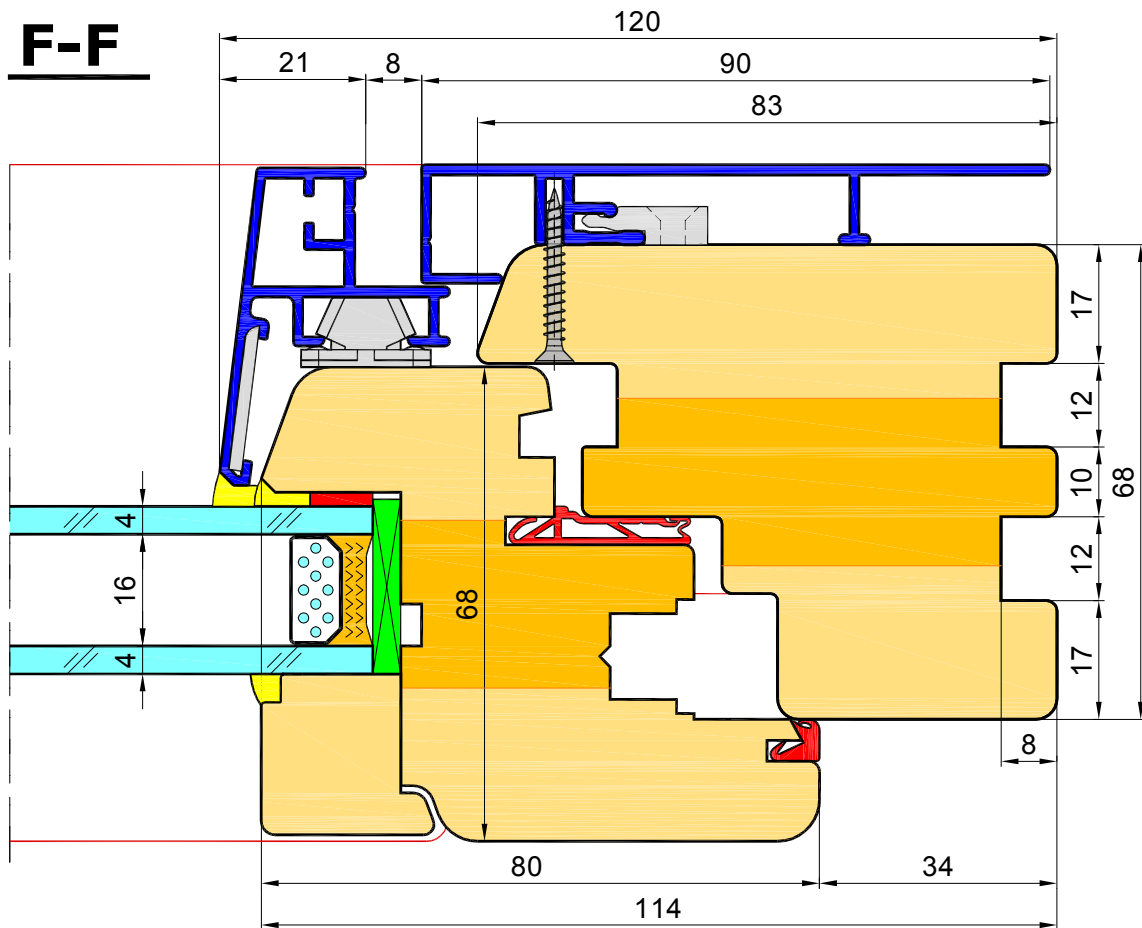
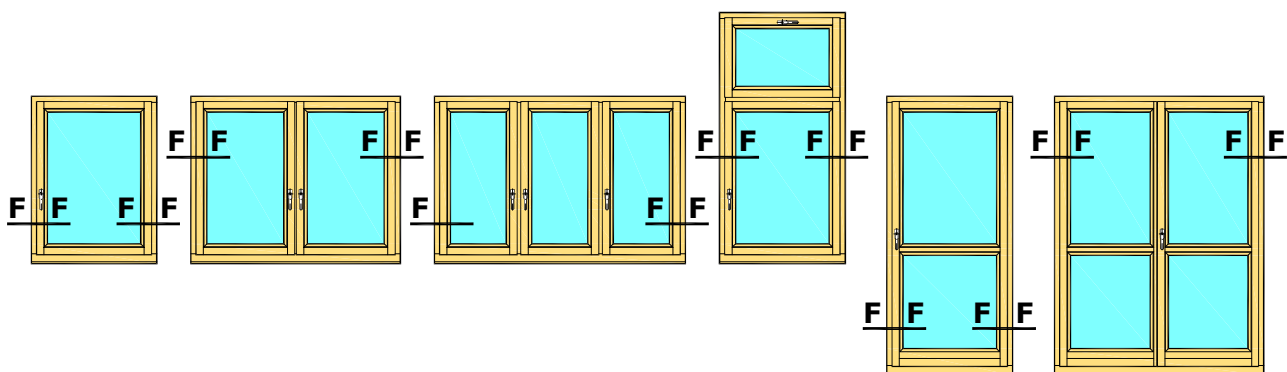

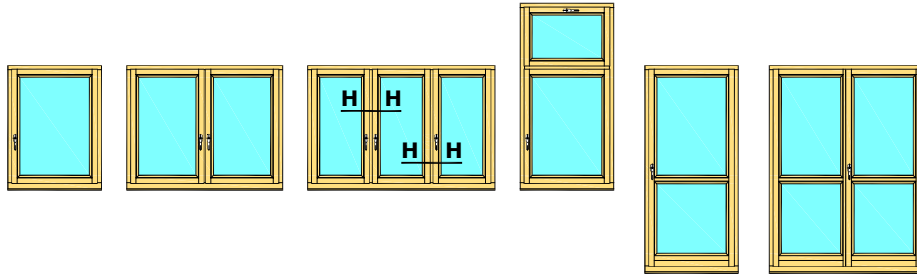

H-H

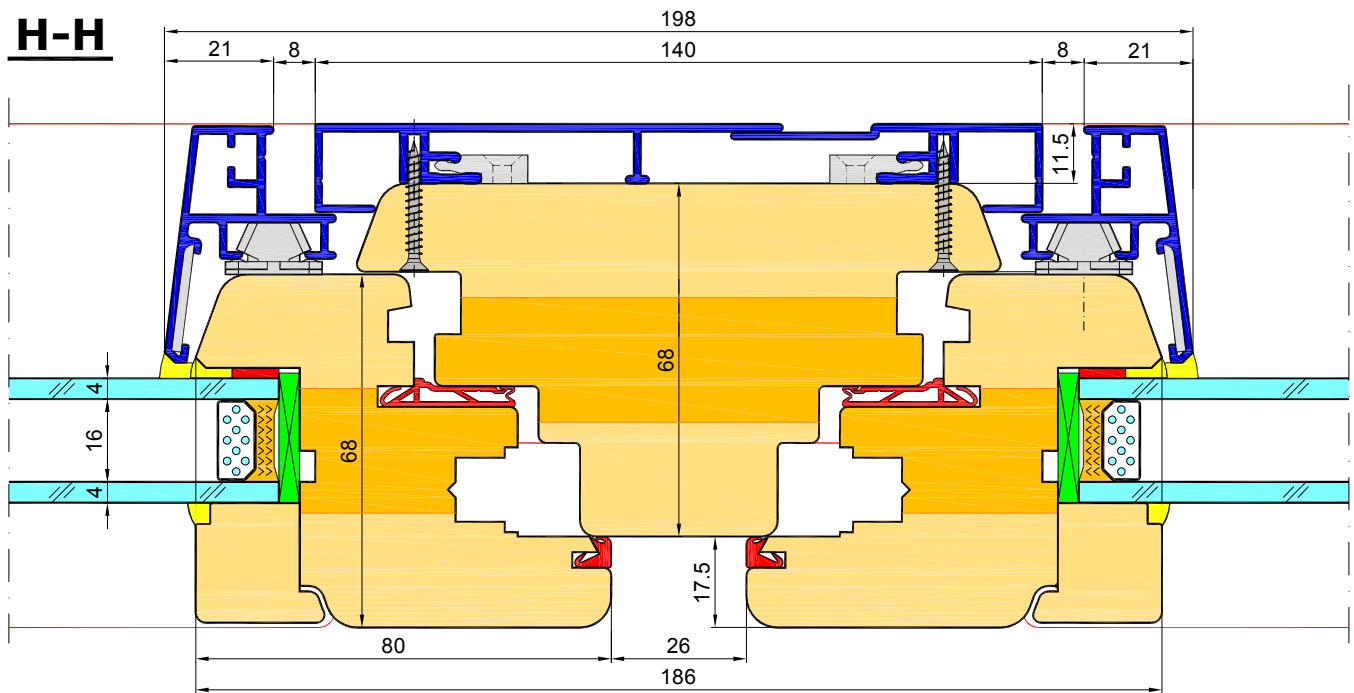

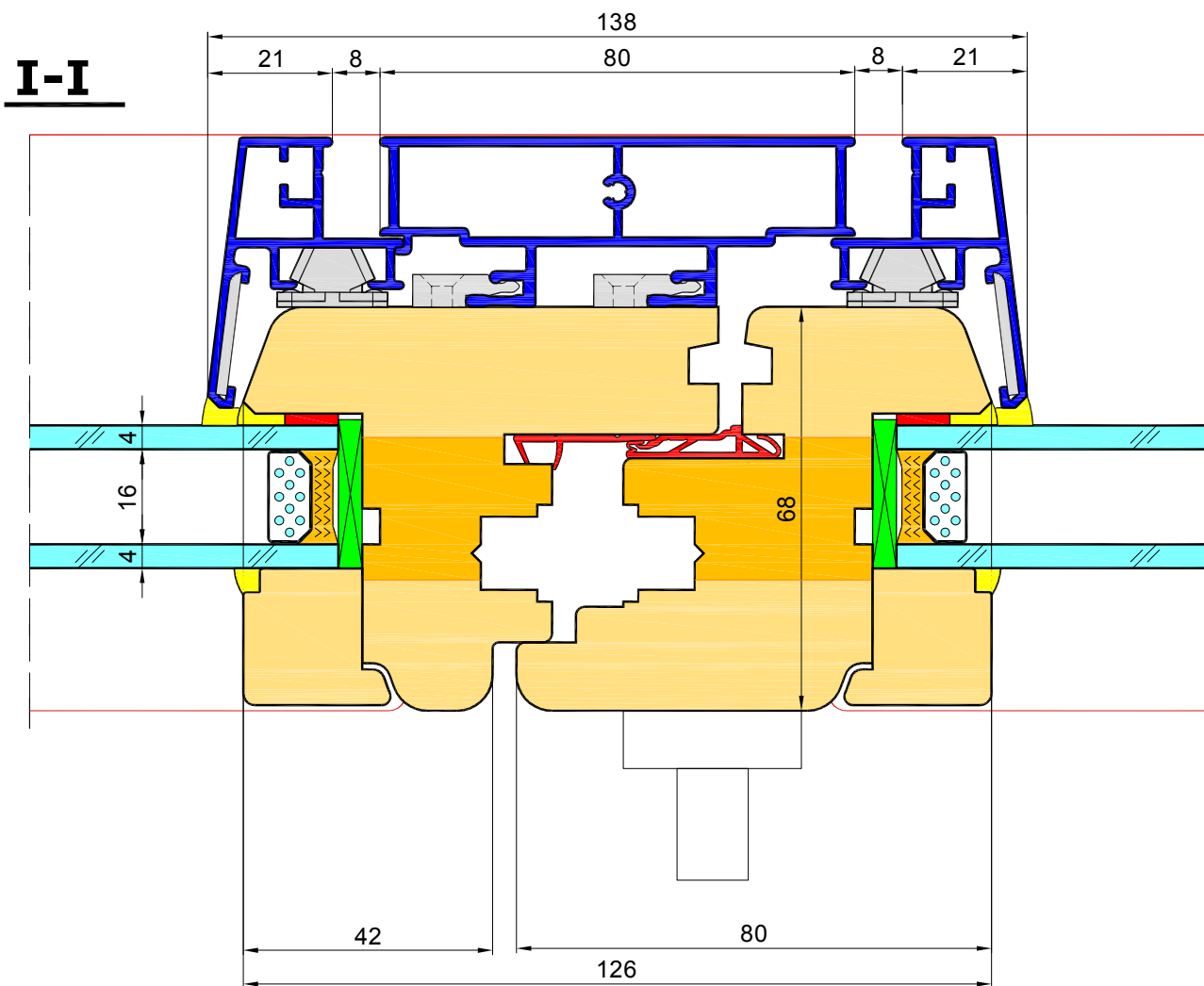
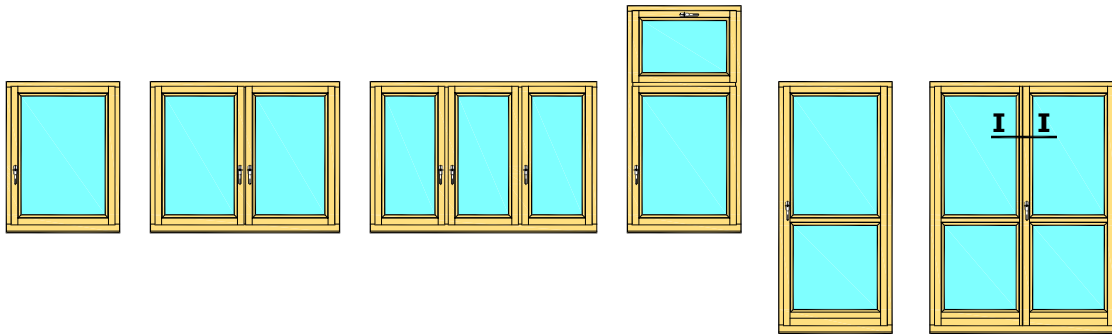

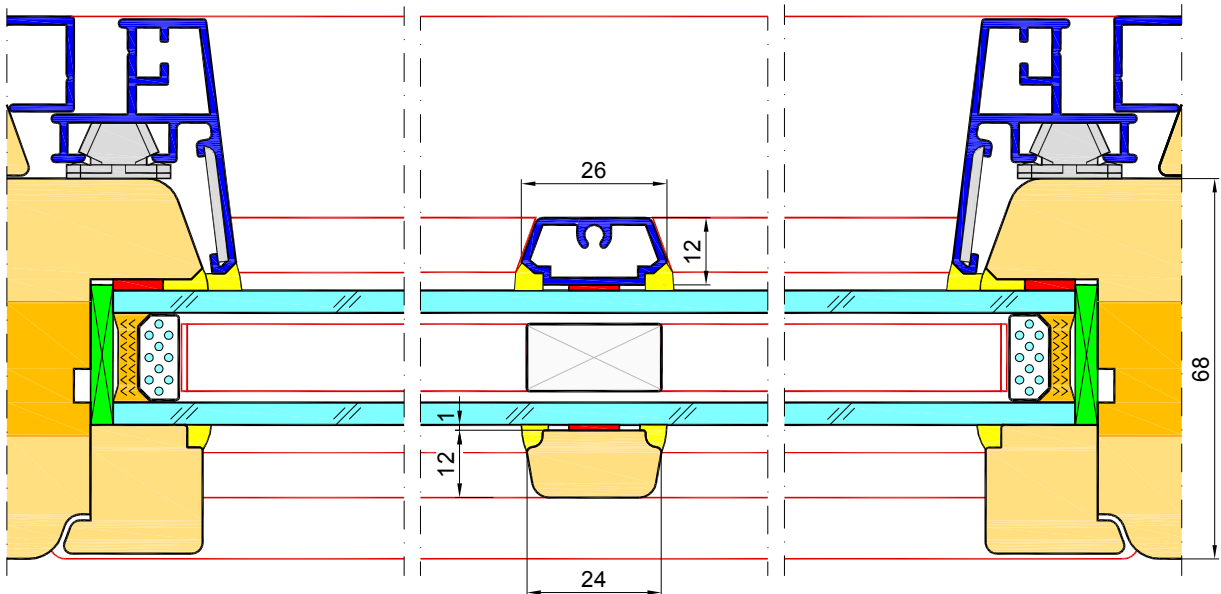
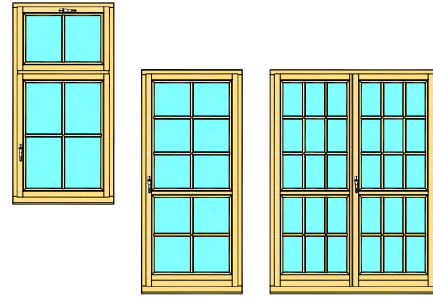
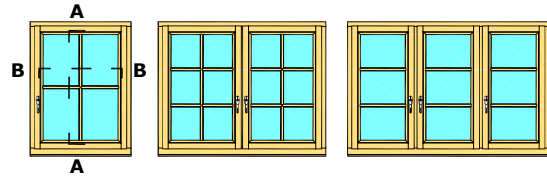
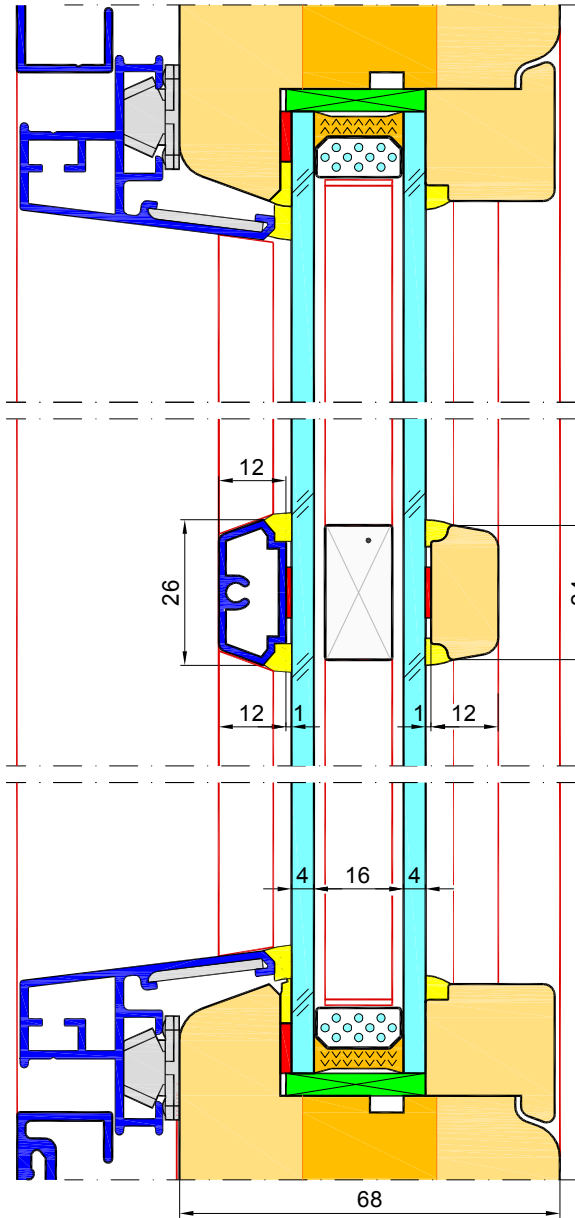

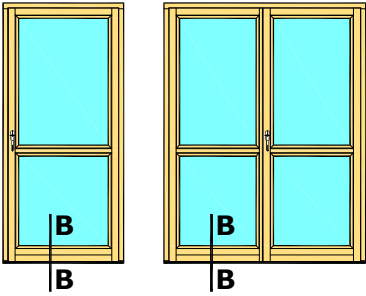

B-B

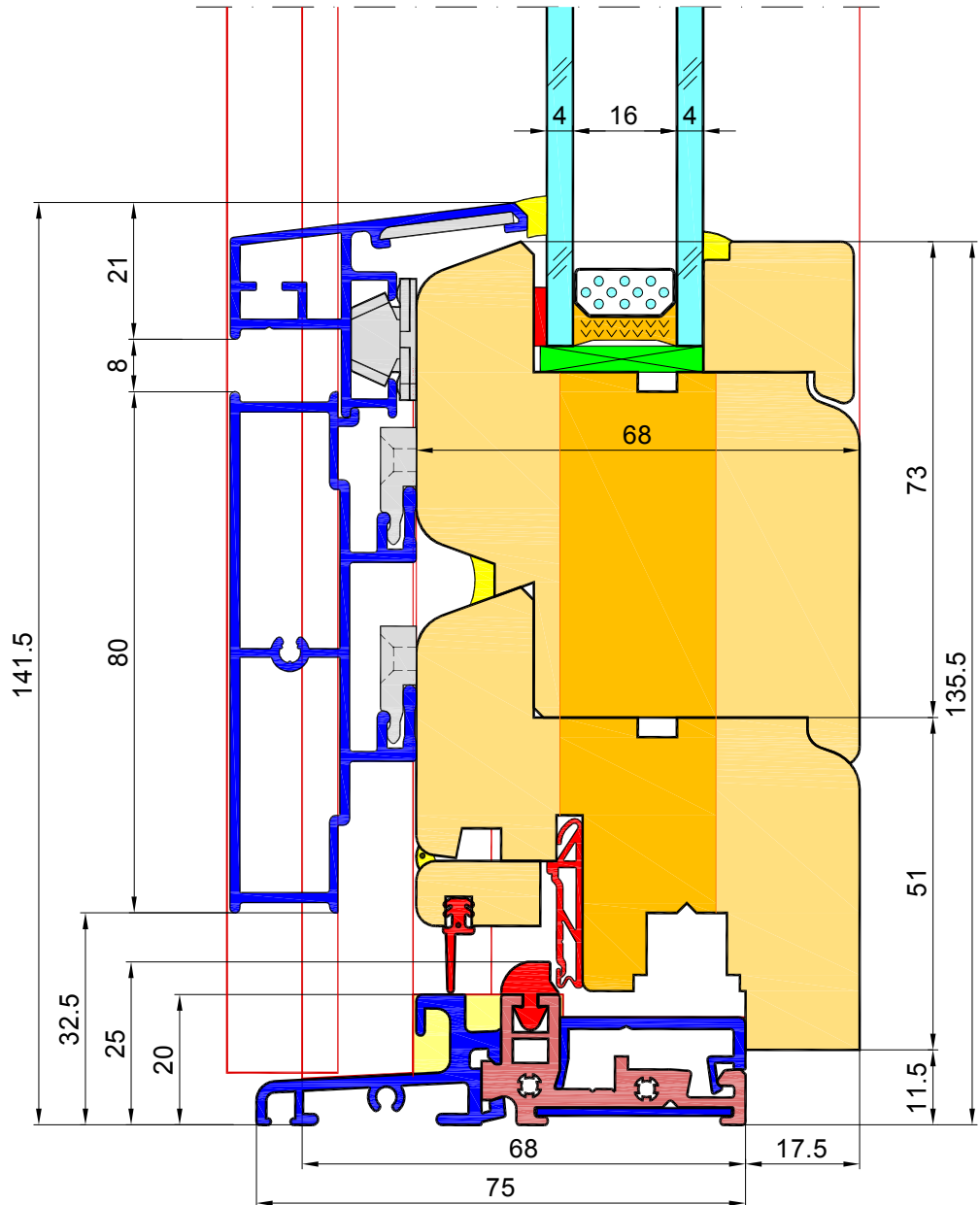

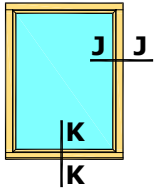

K-K

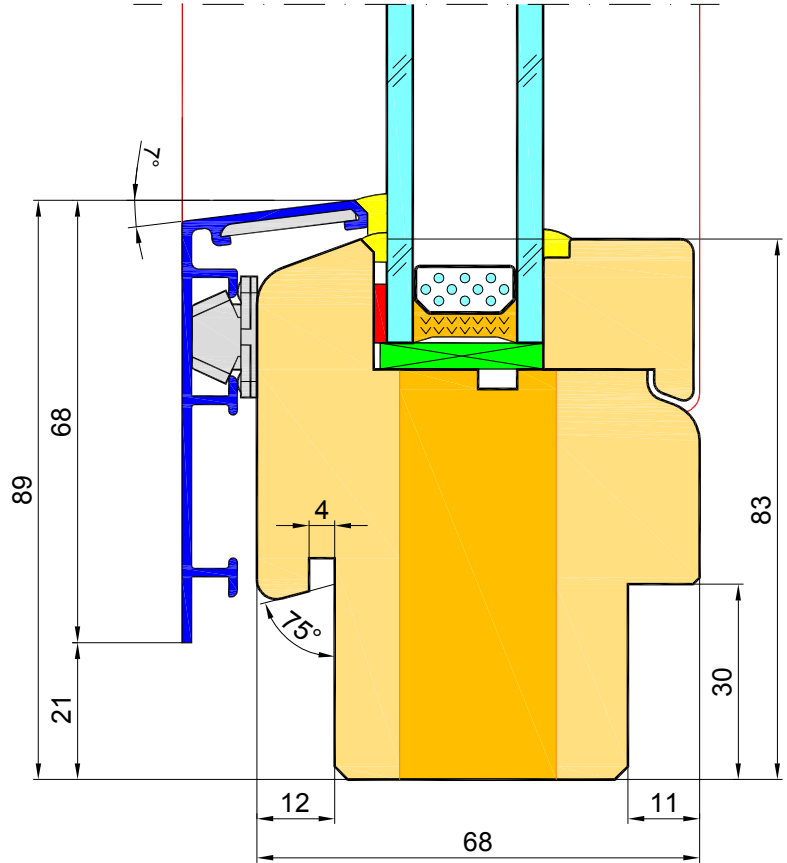

J-J

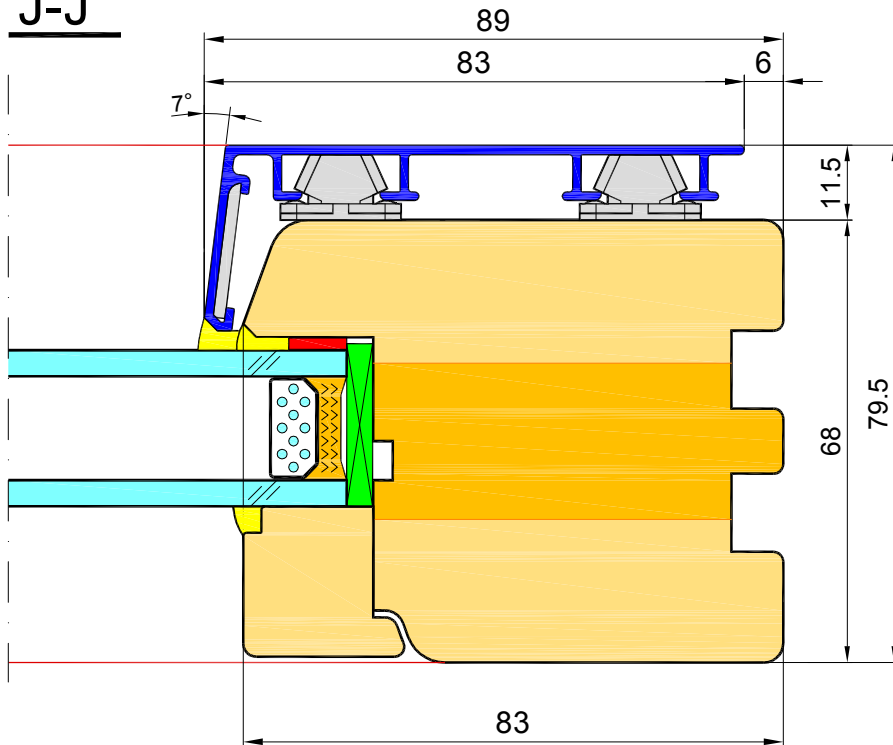

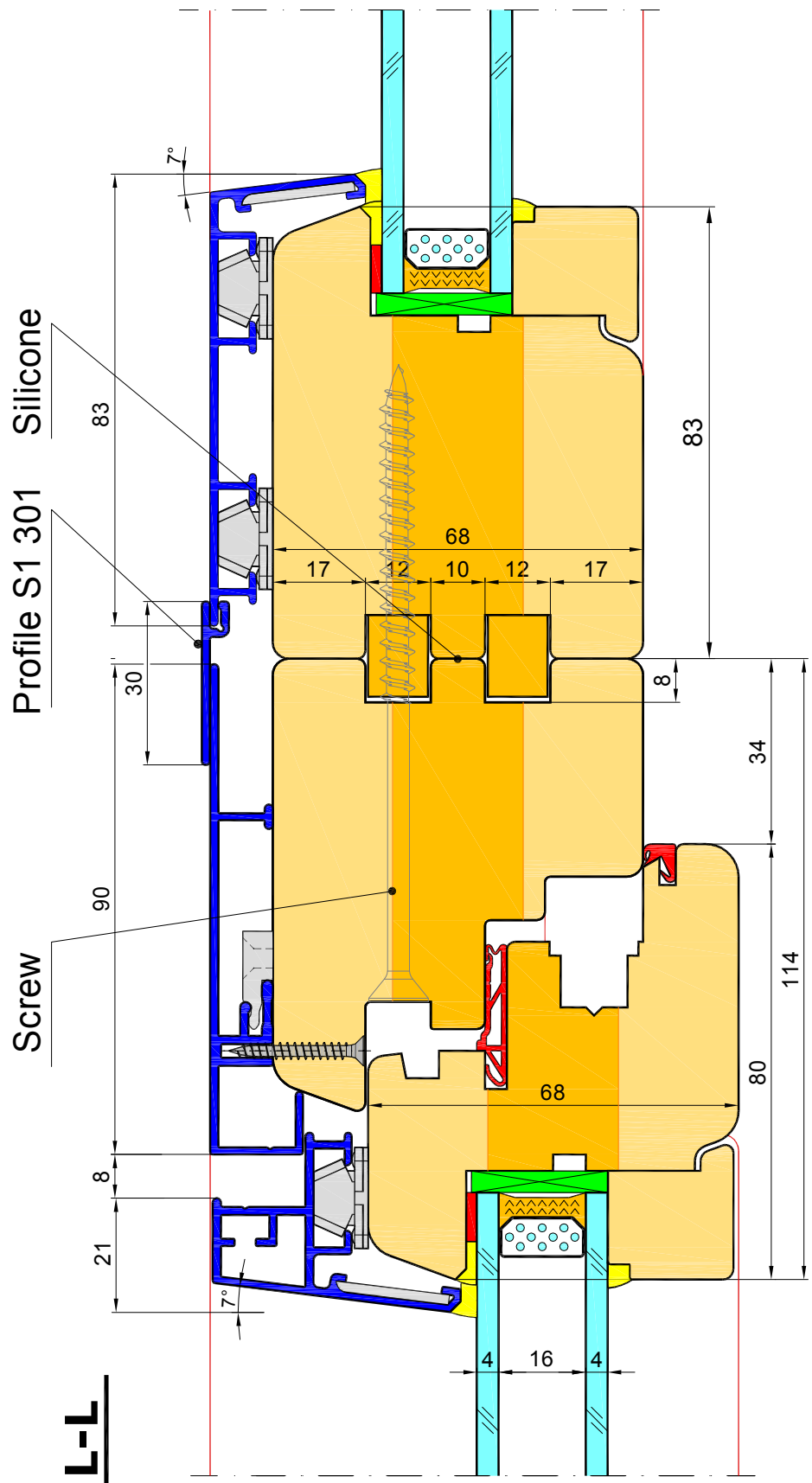
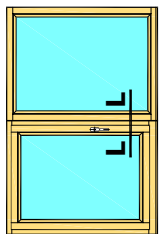

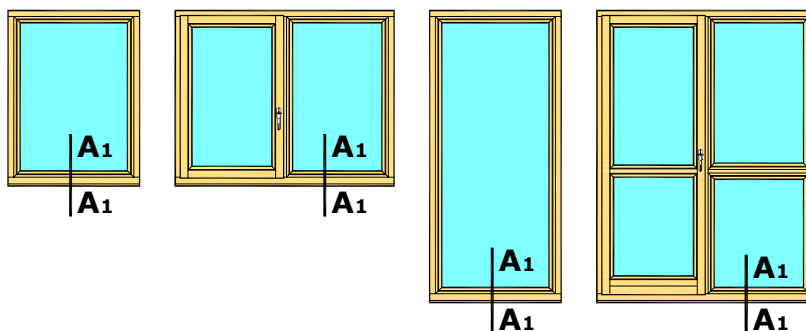

A1-A1

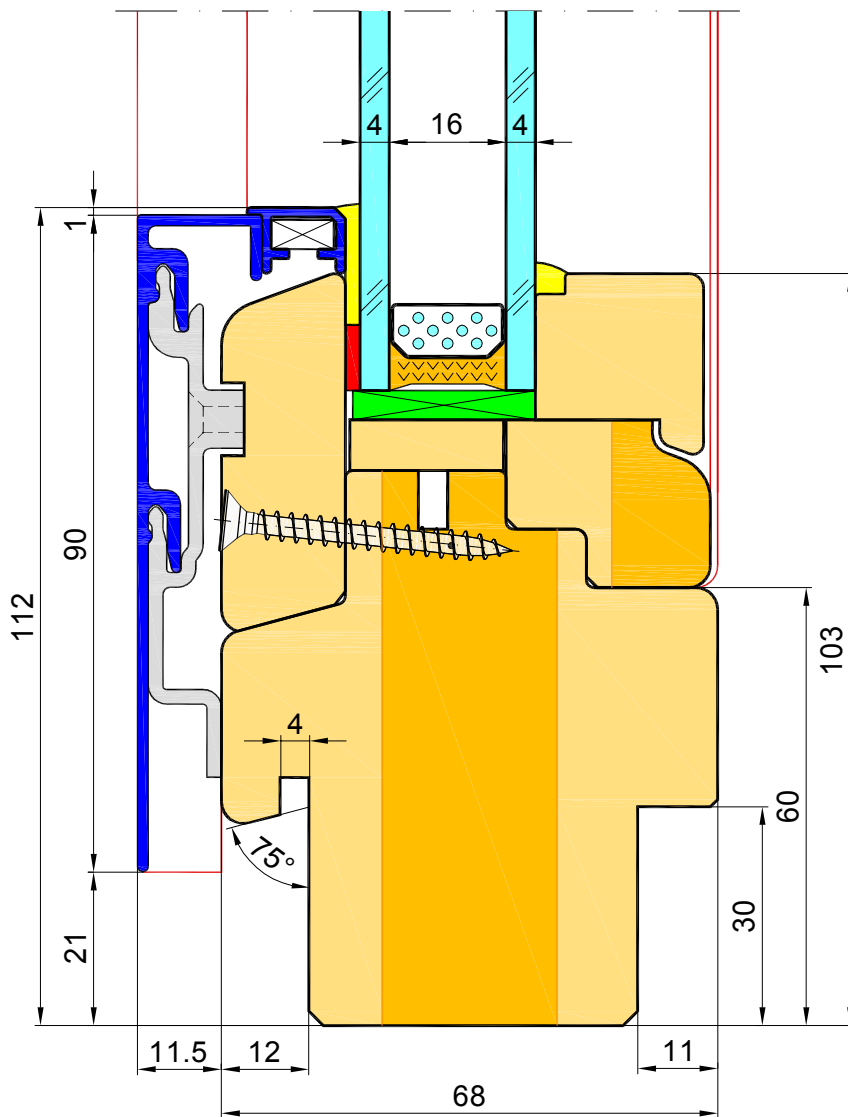

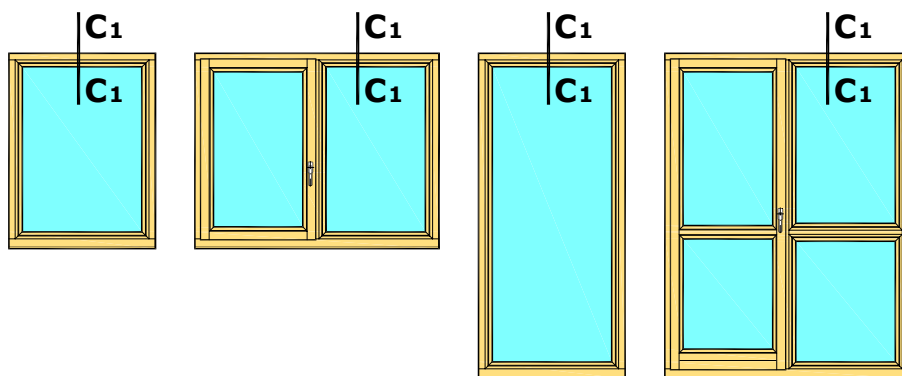

C1-C1

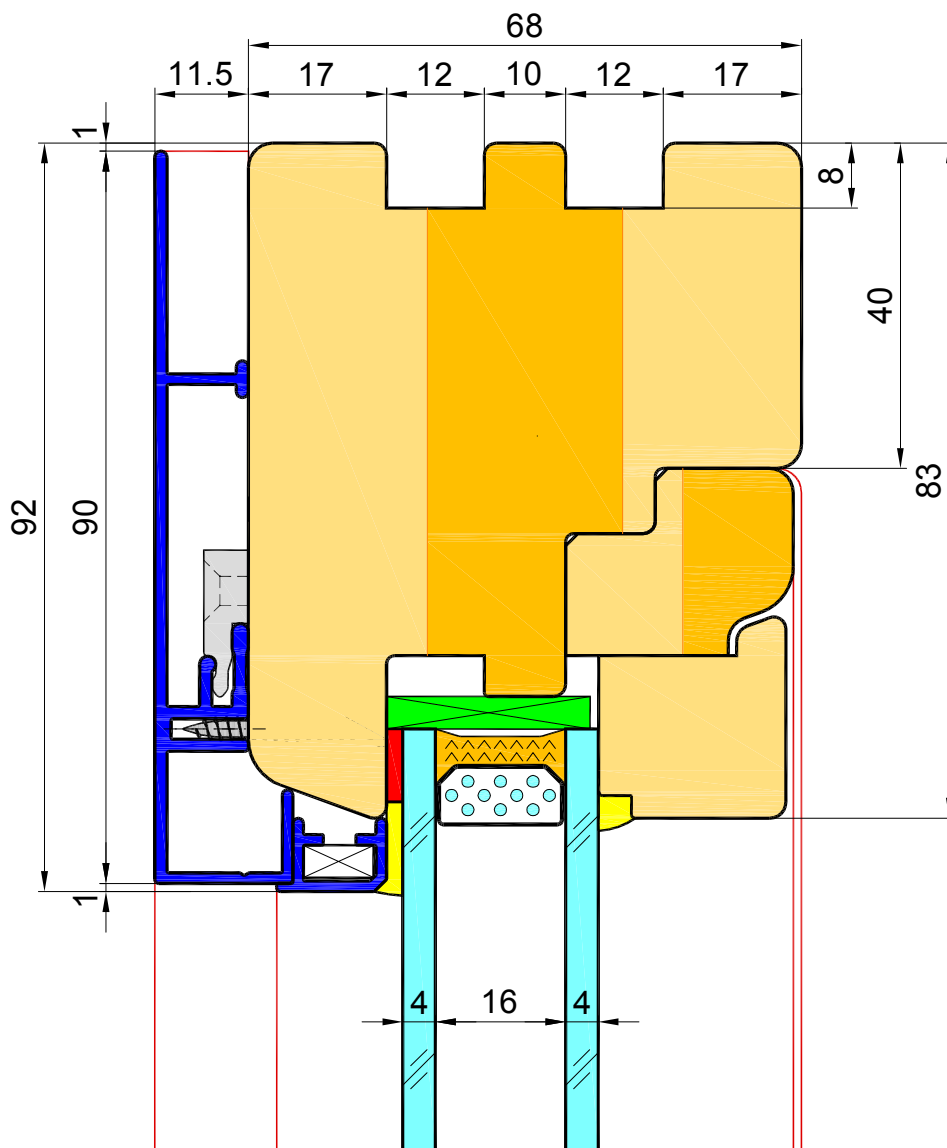

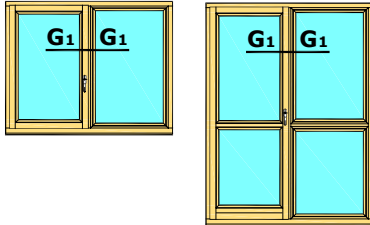

G1-G1

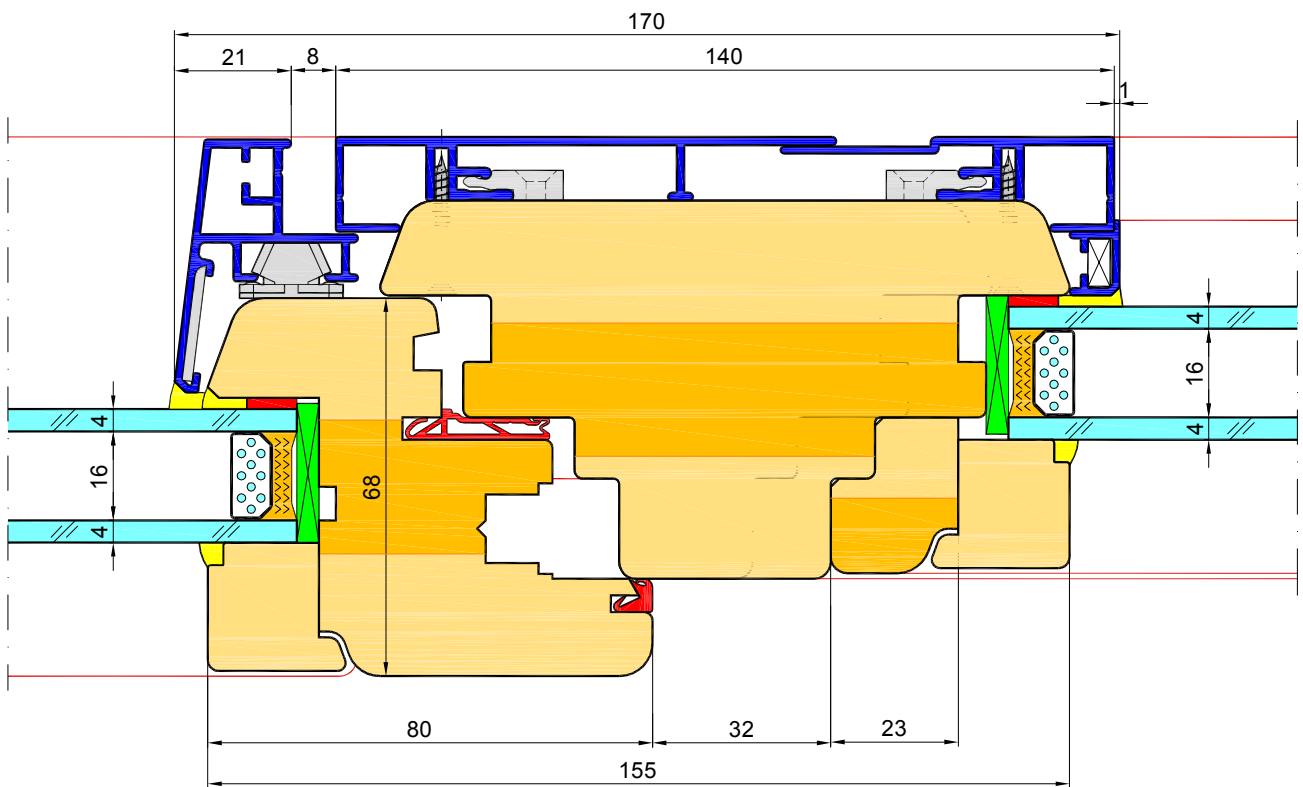

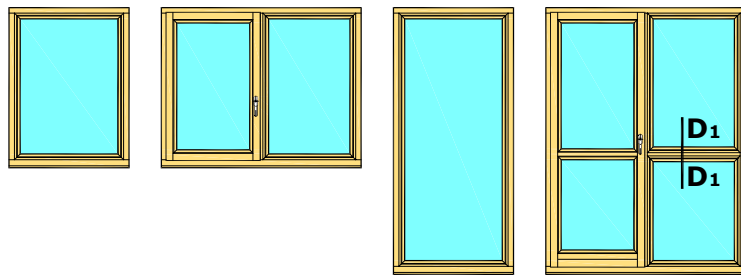

D₁-D₁

