

A-A

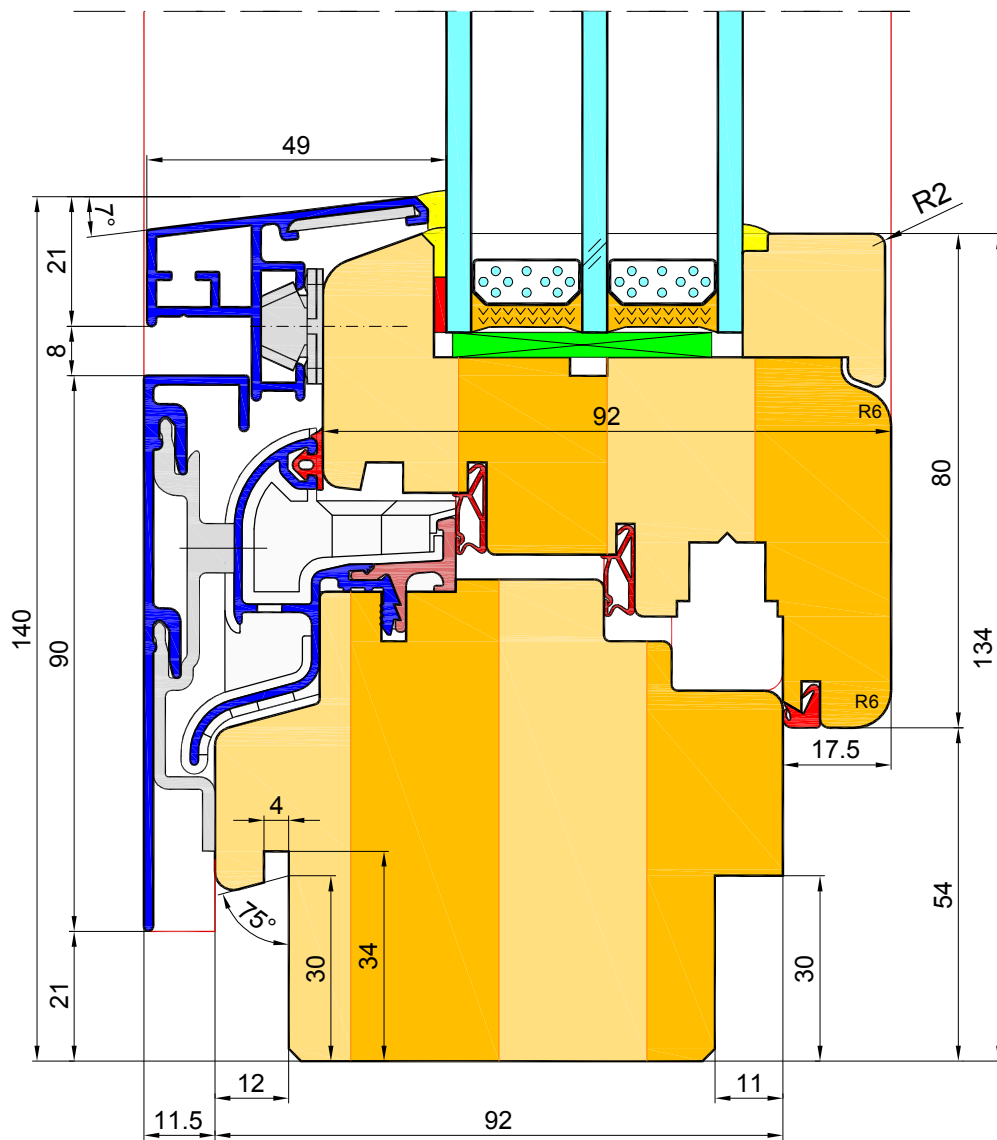

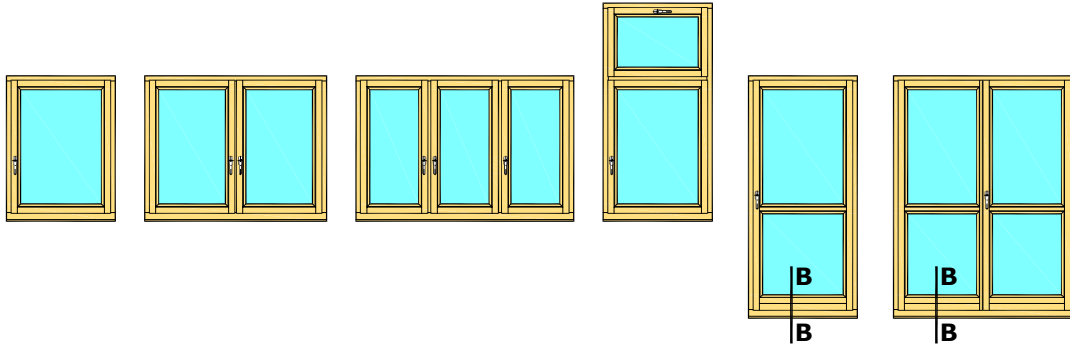

B-B

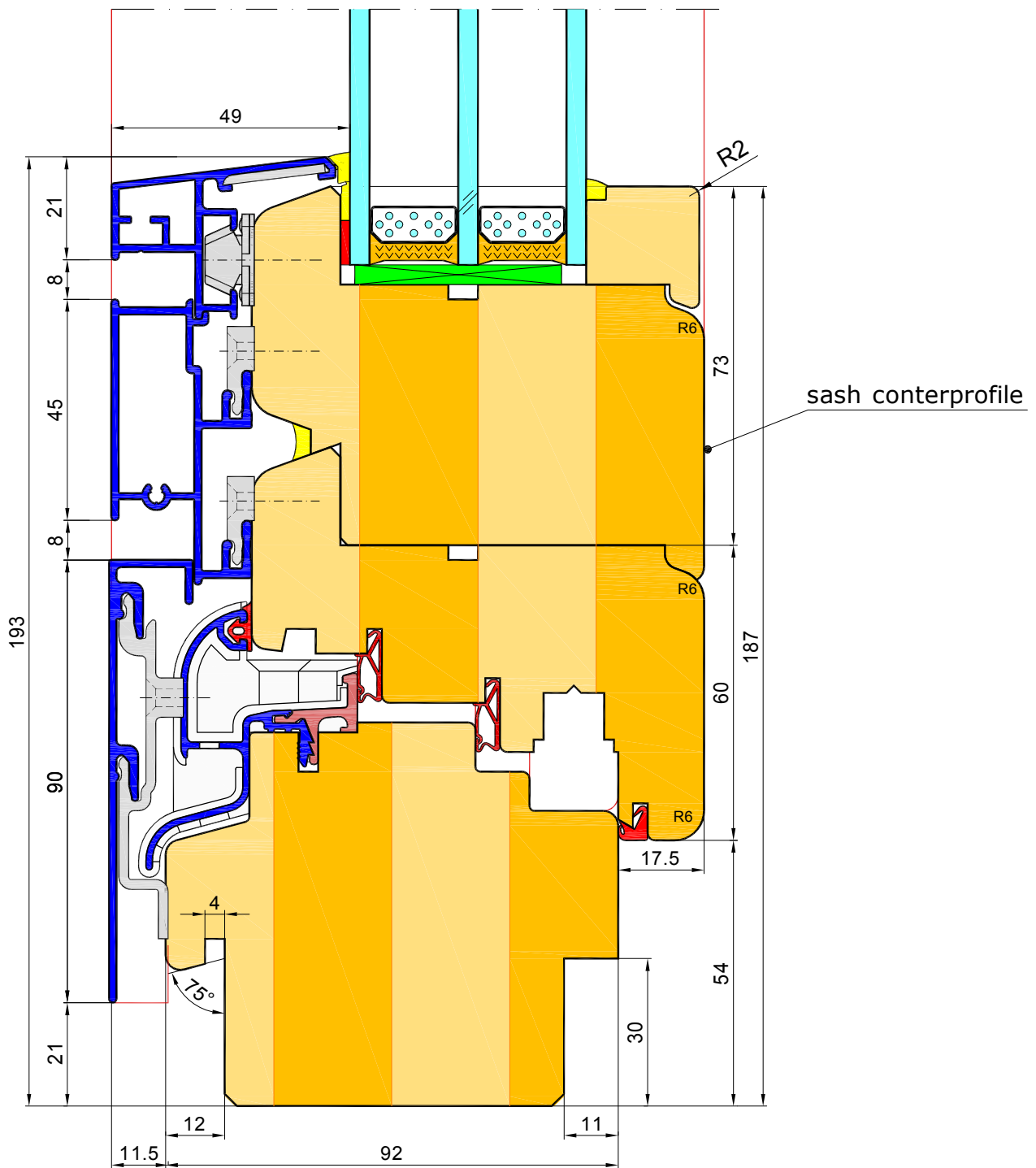

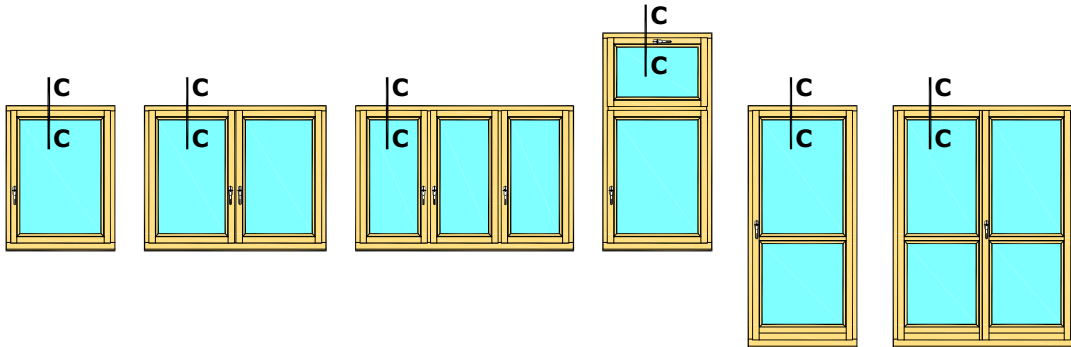

C-C

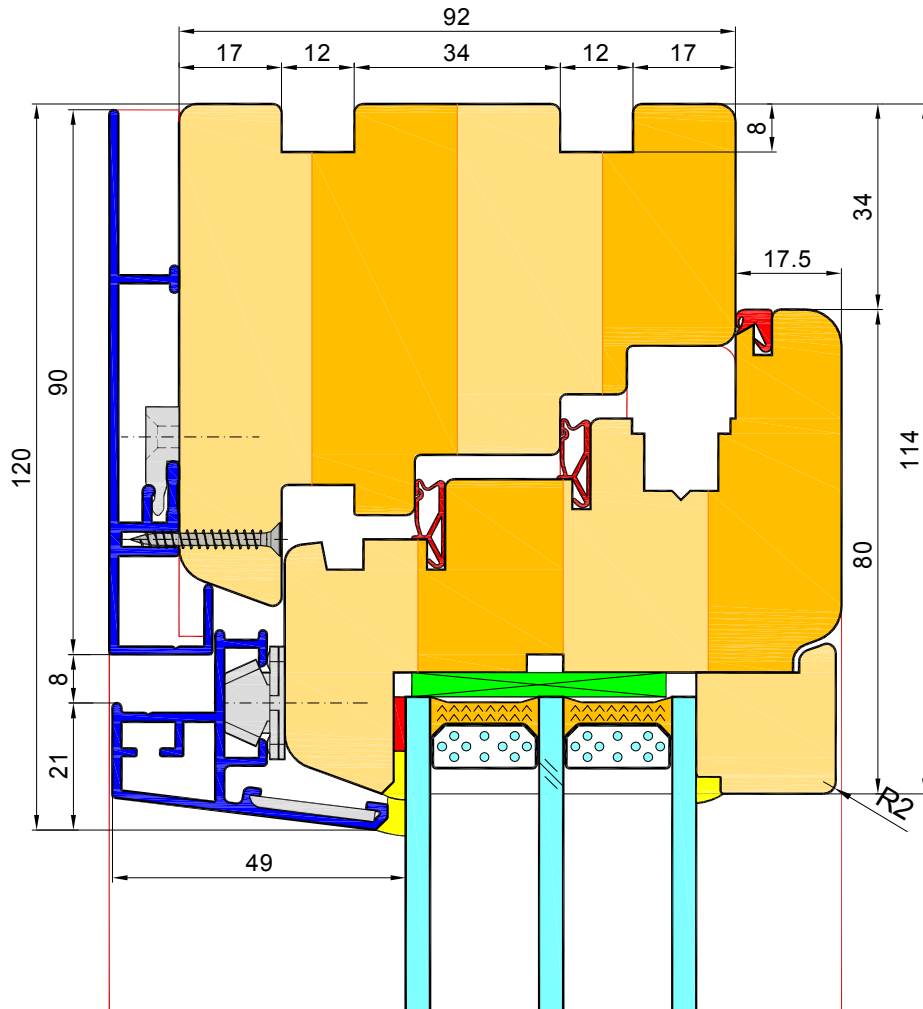

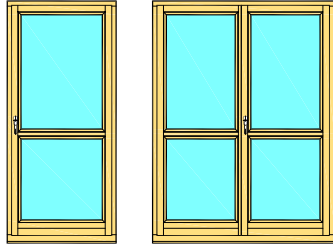
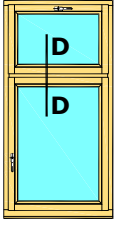

D-D

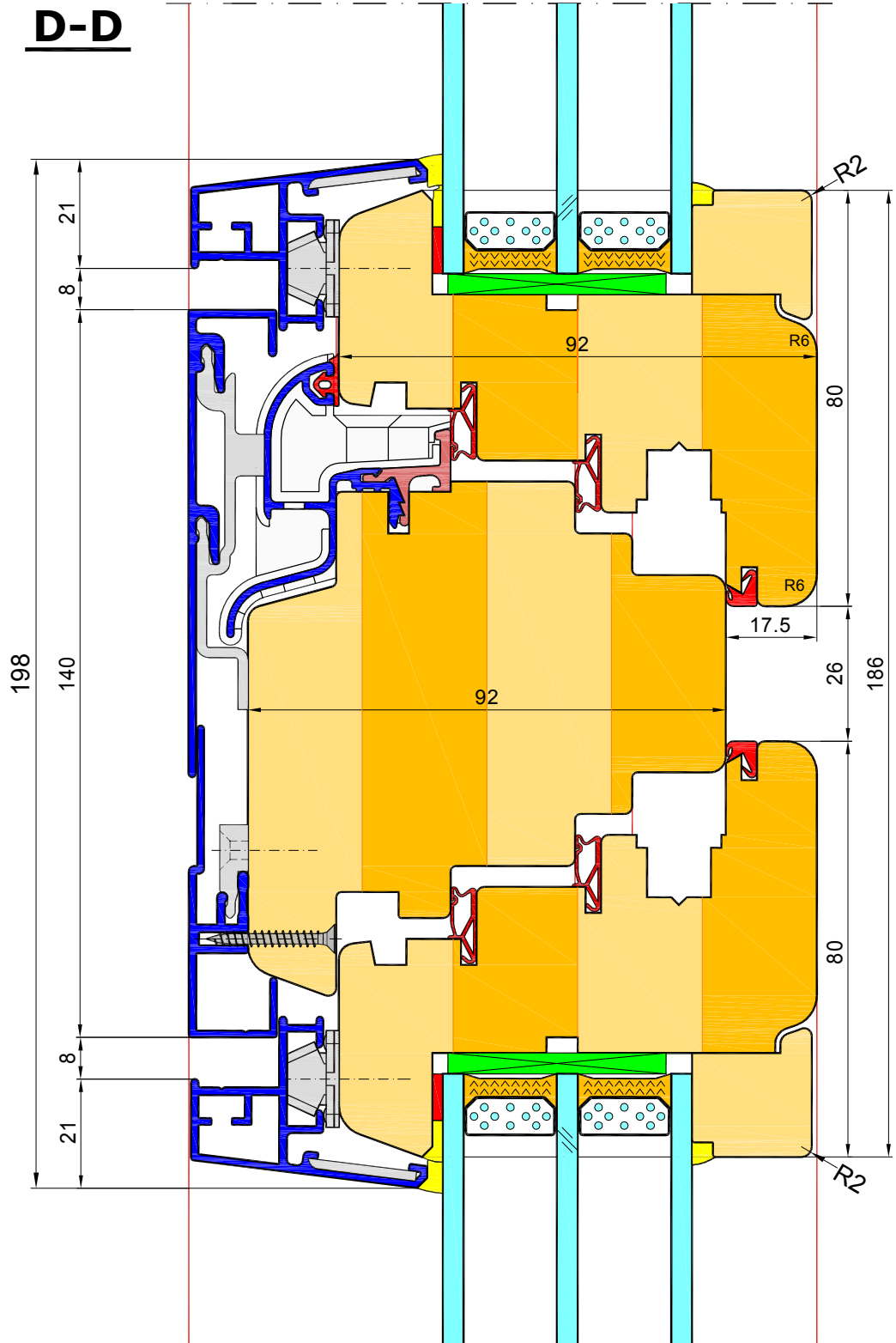

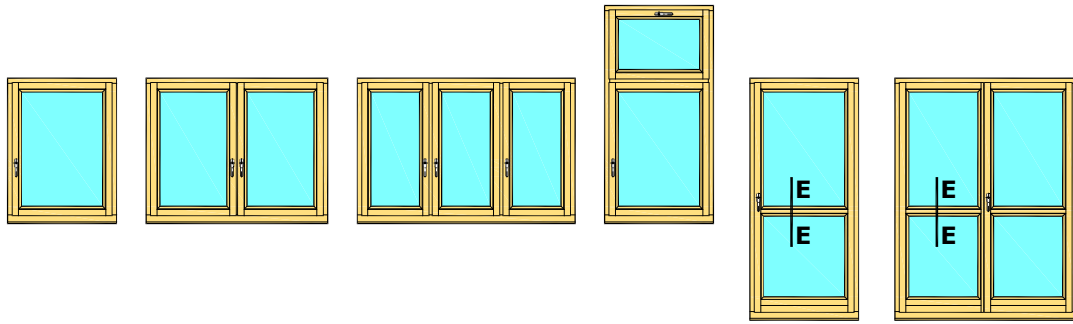

E-E

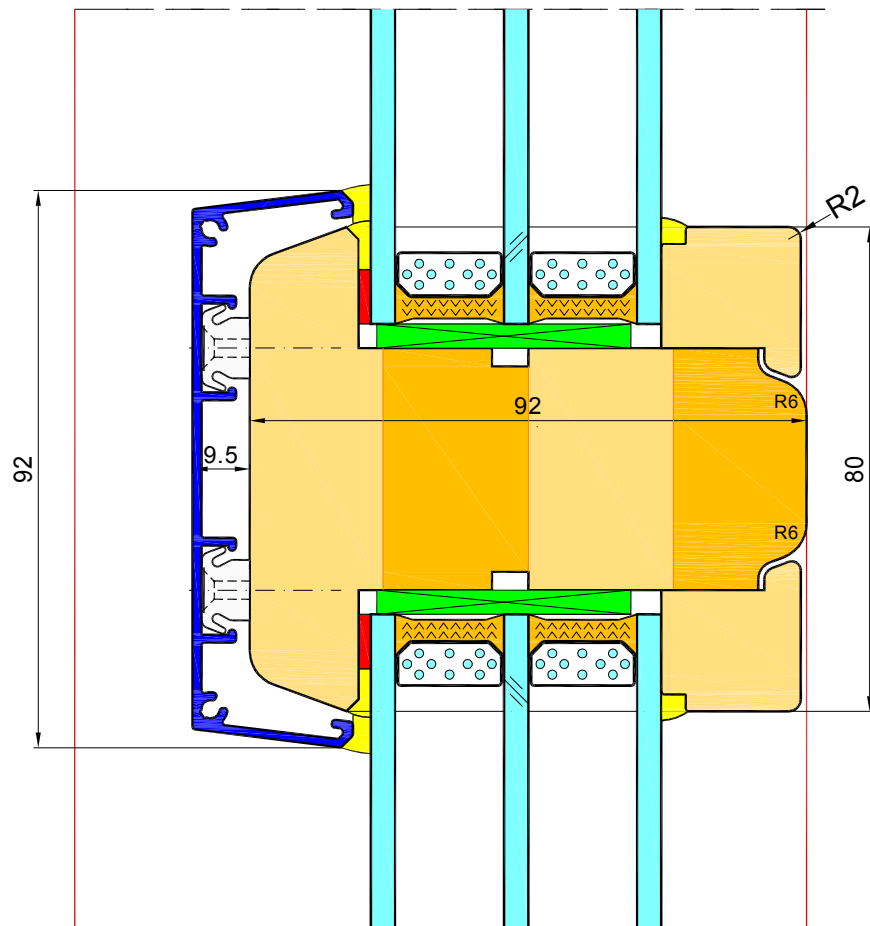

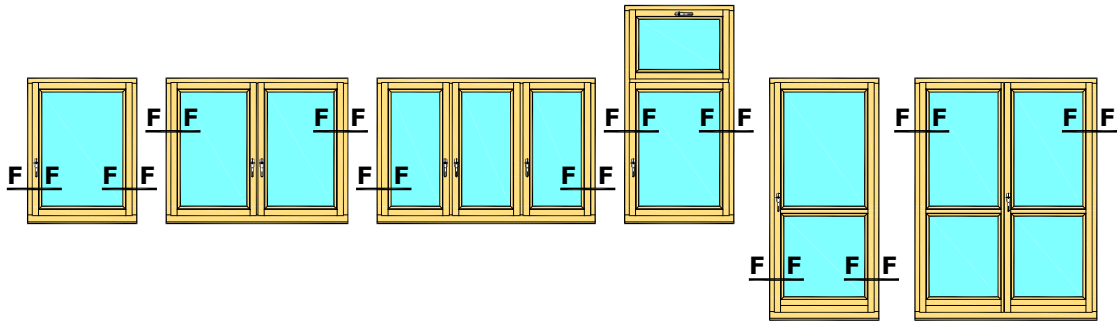

F-F

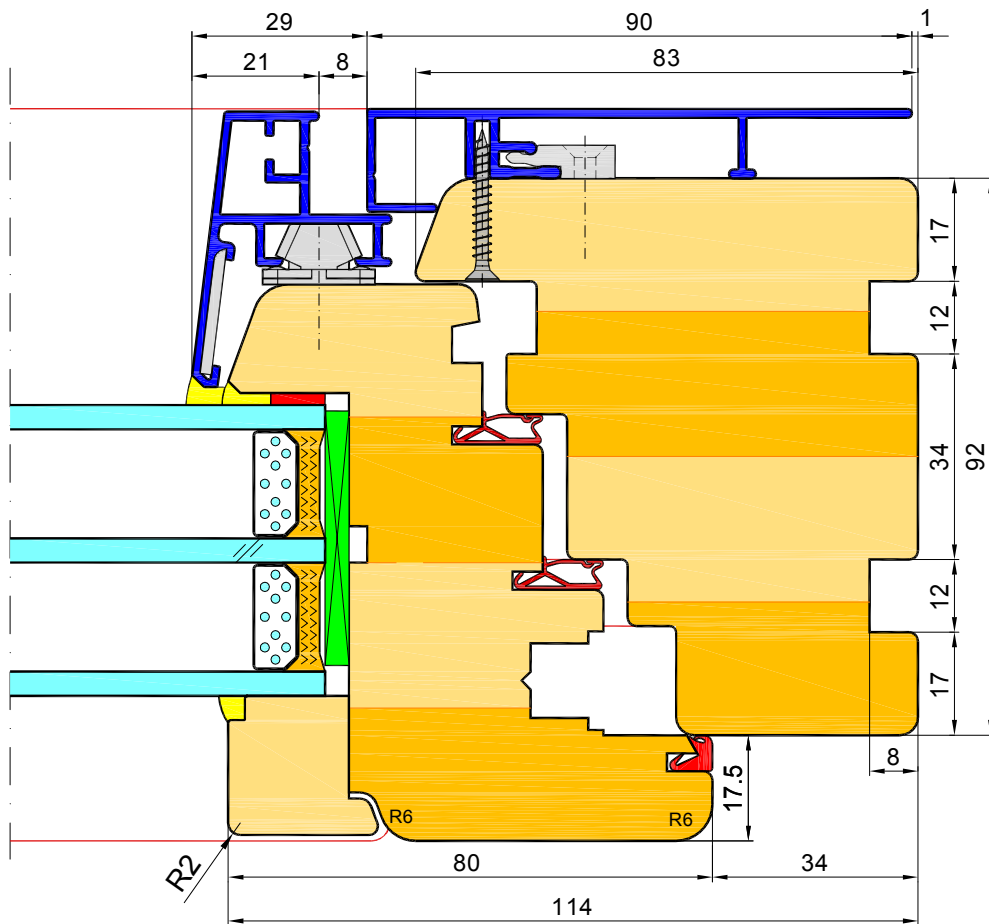

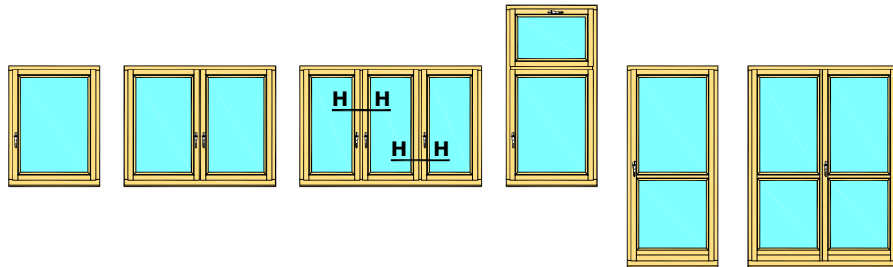

H-H

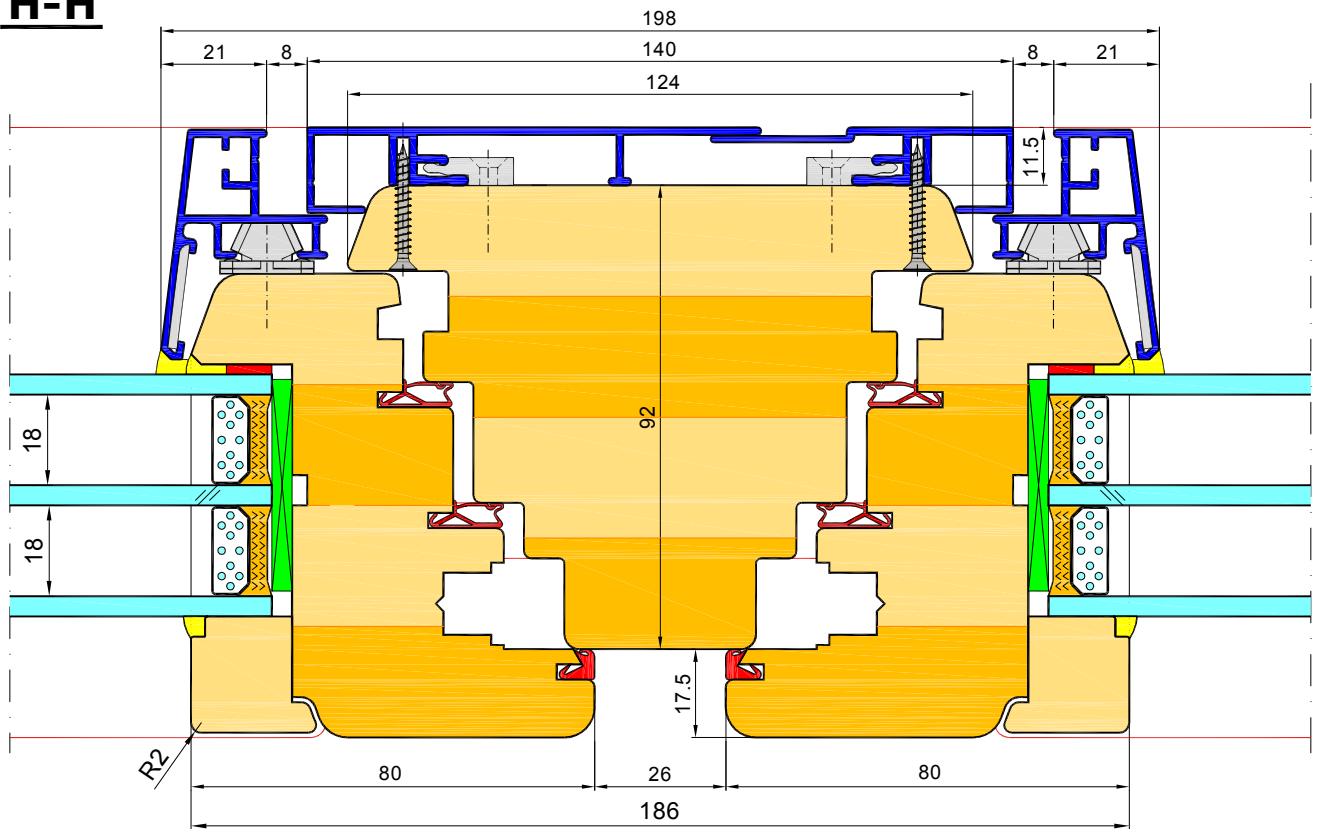

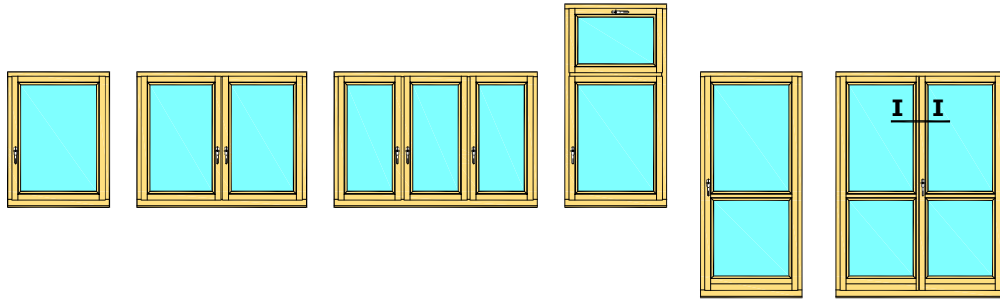

I-I

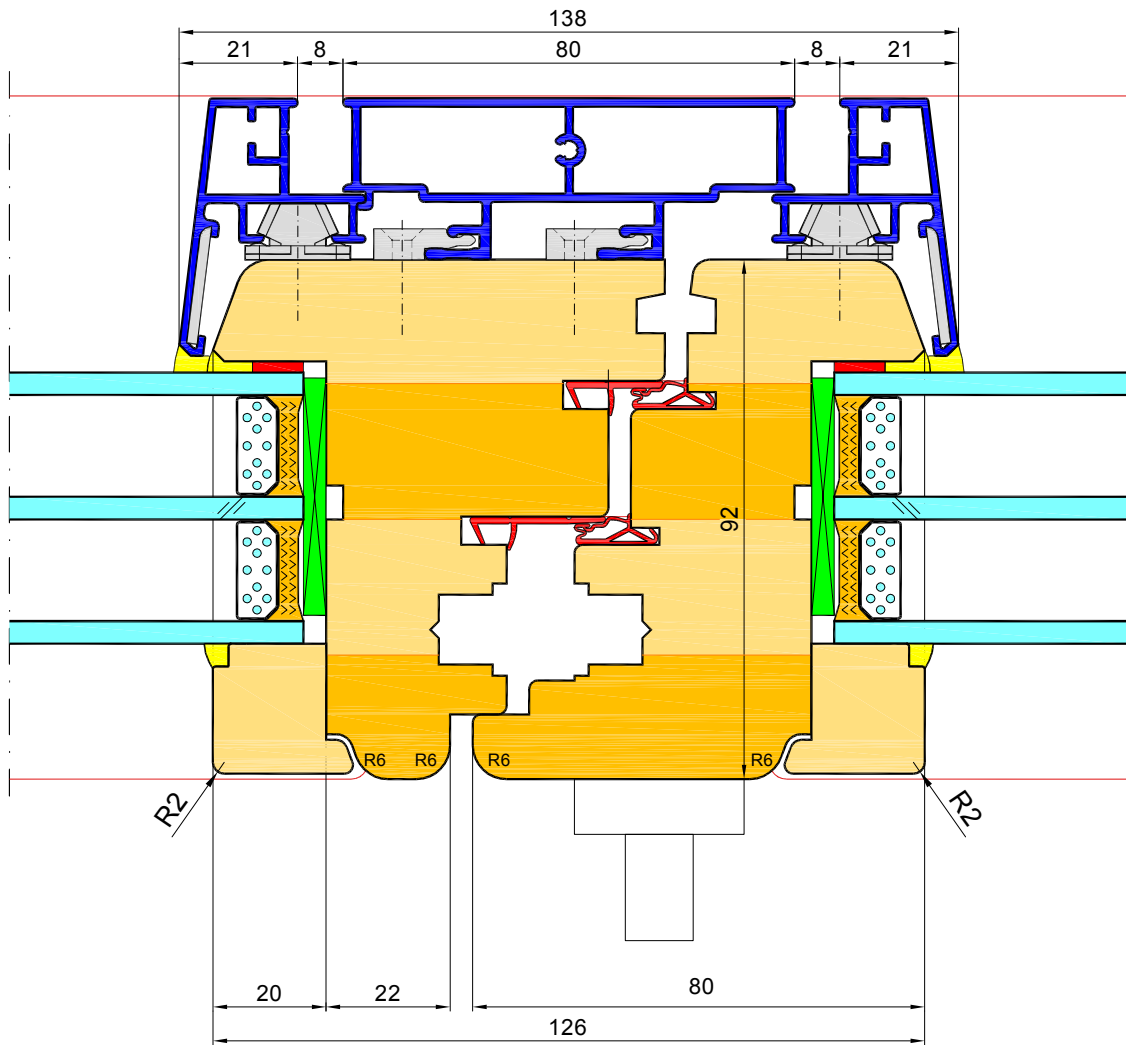

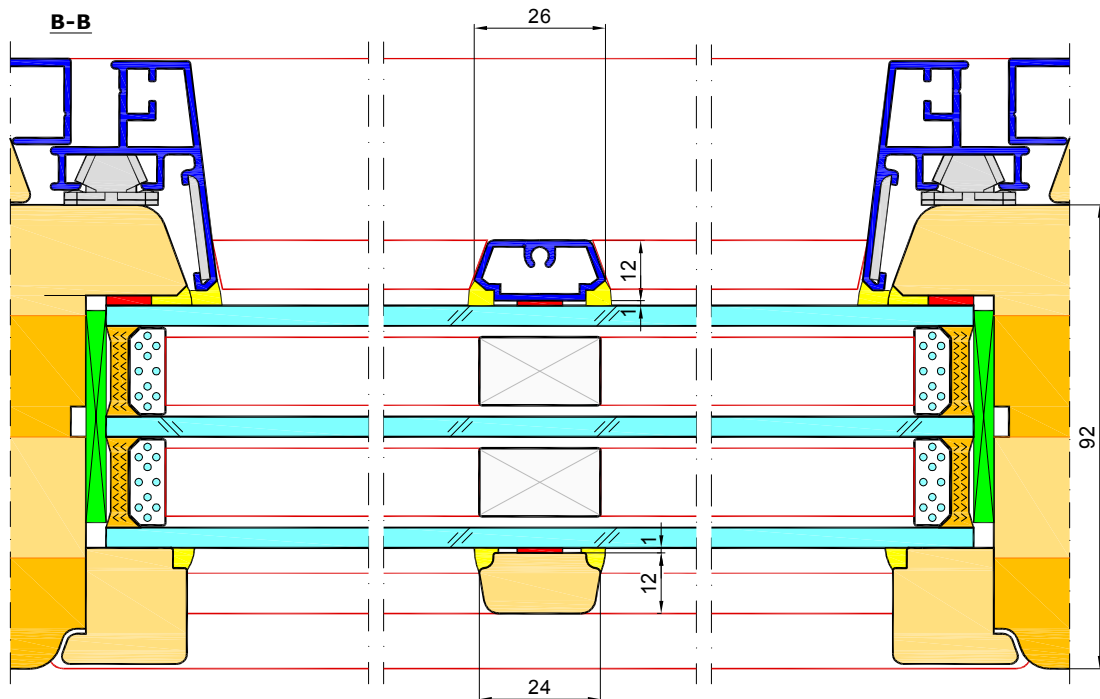
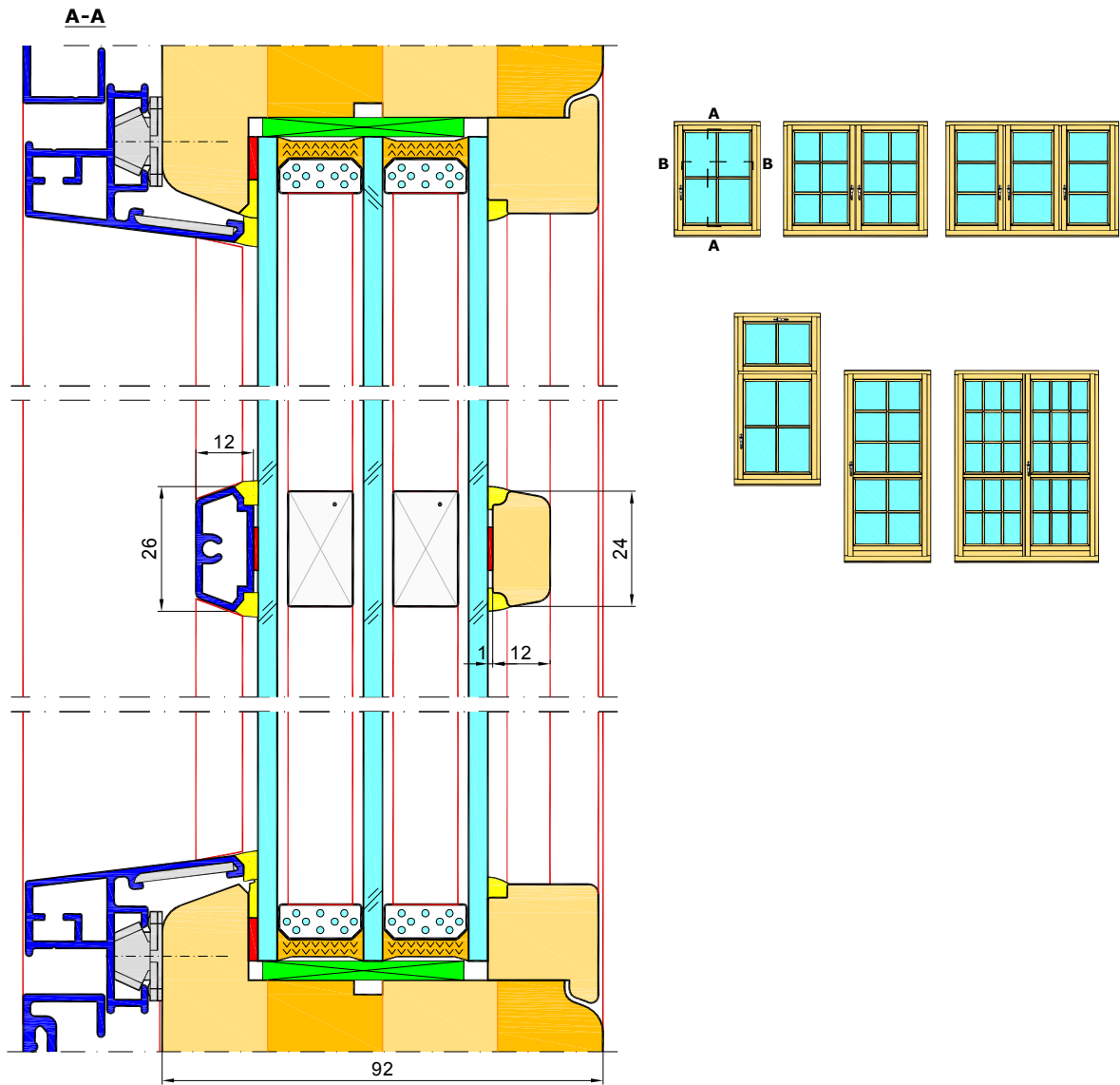

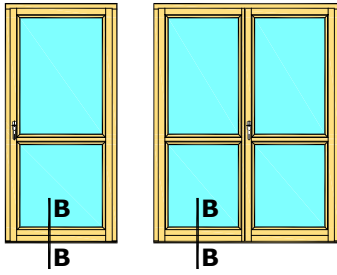

B-B

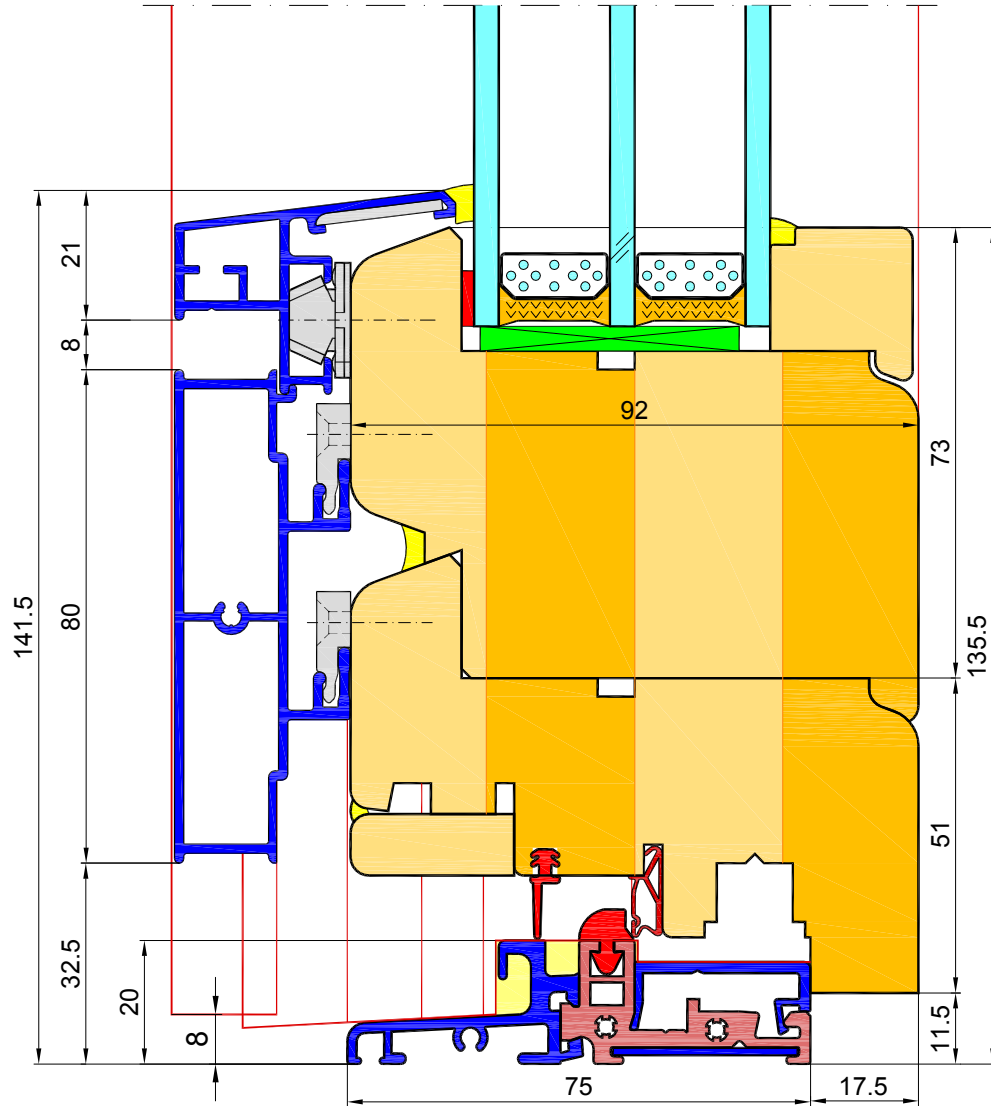

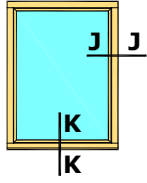

K-K

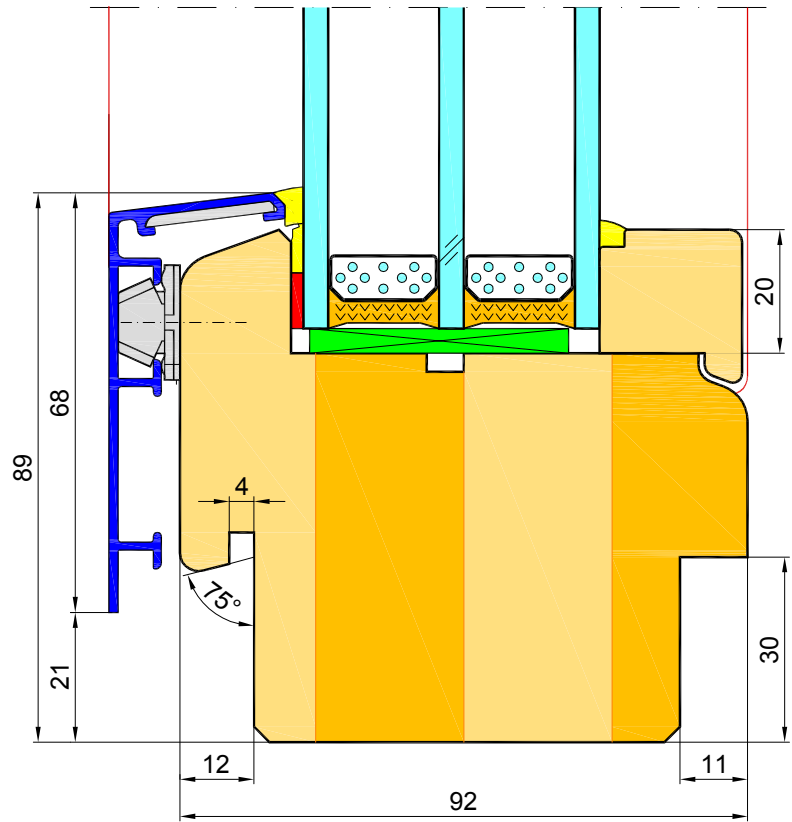

J-J

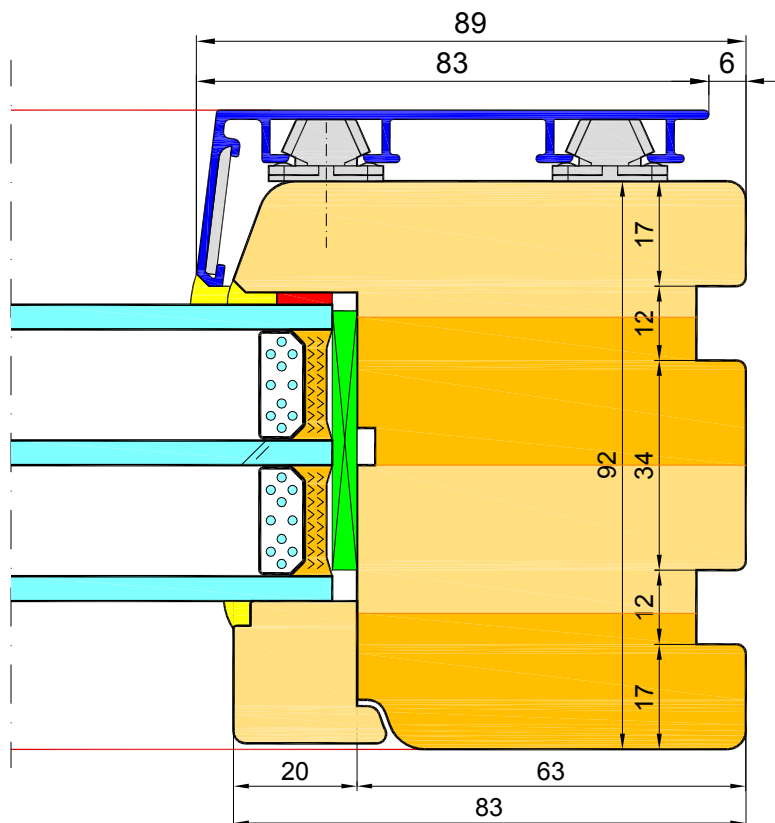

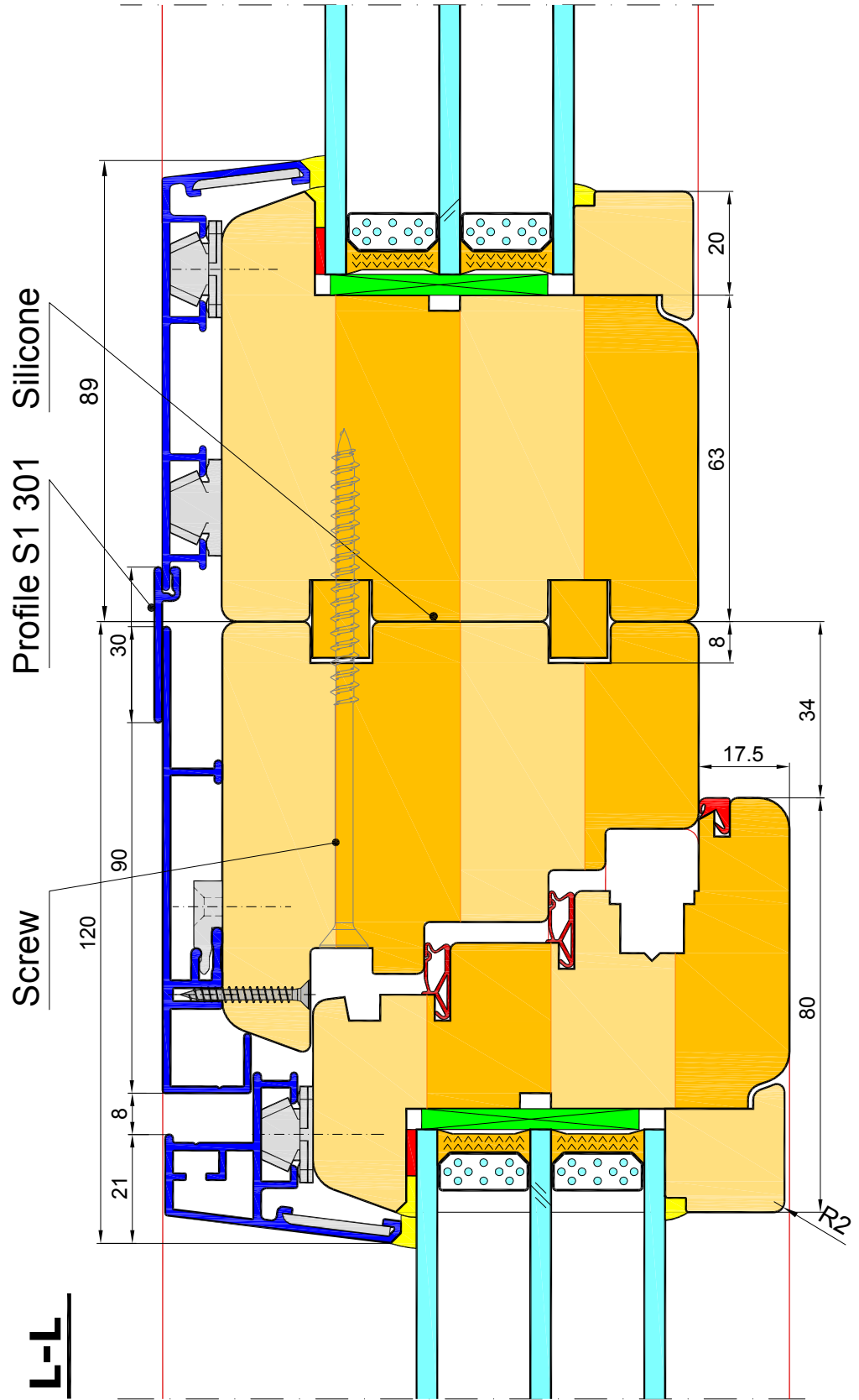
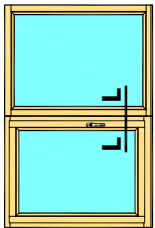

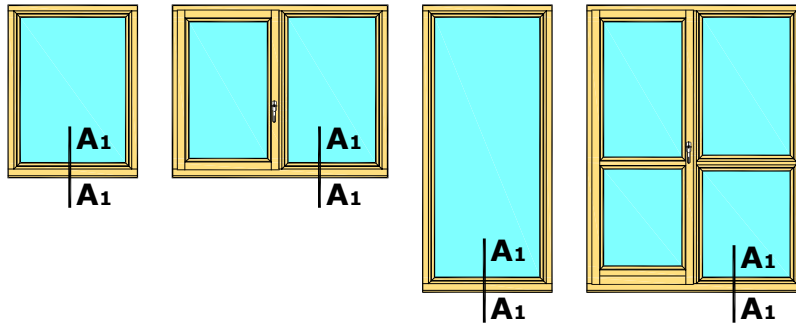

A₁-A₁

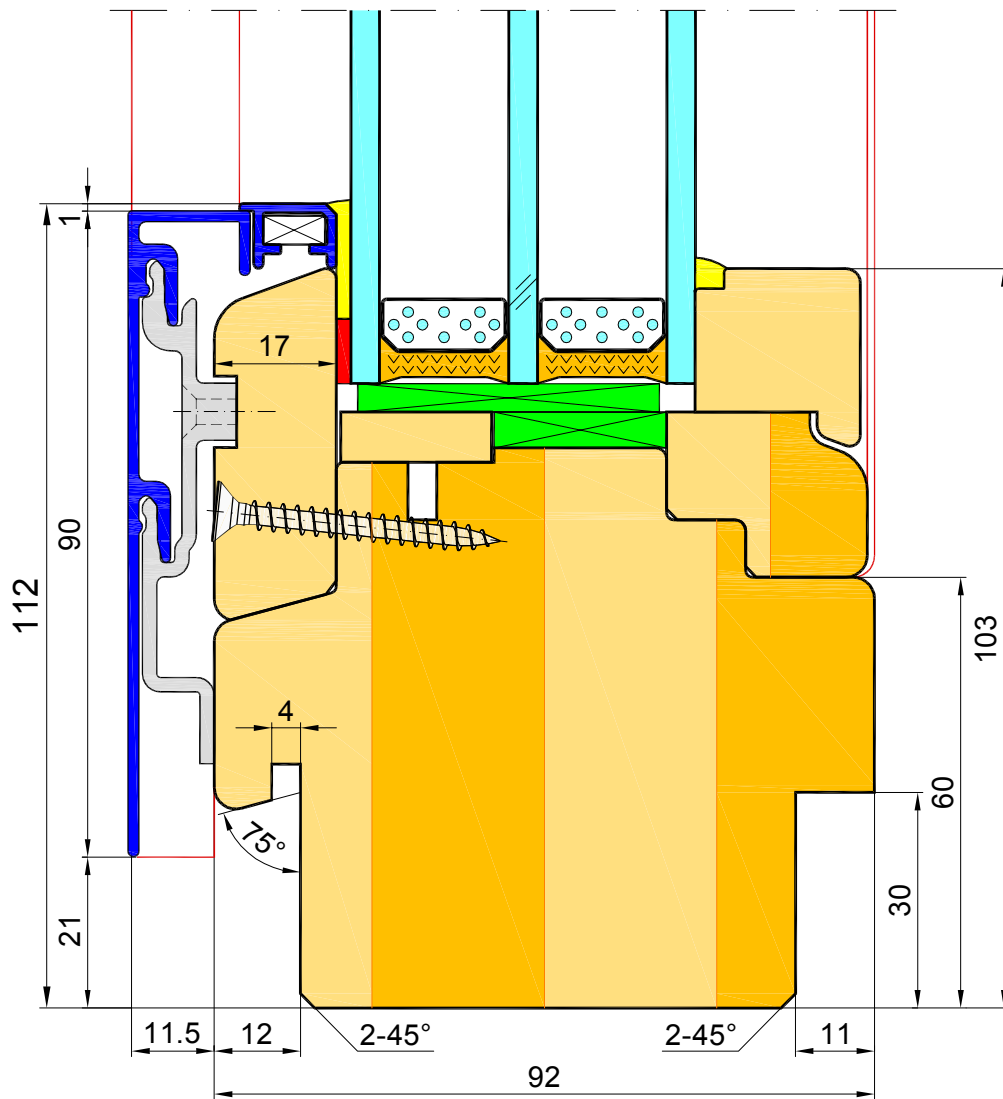

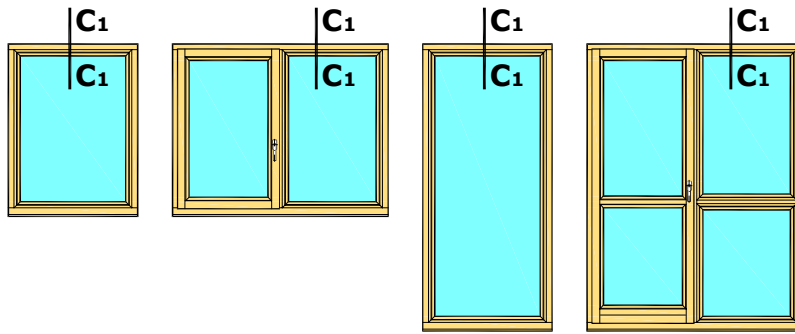

C1-C1

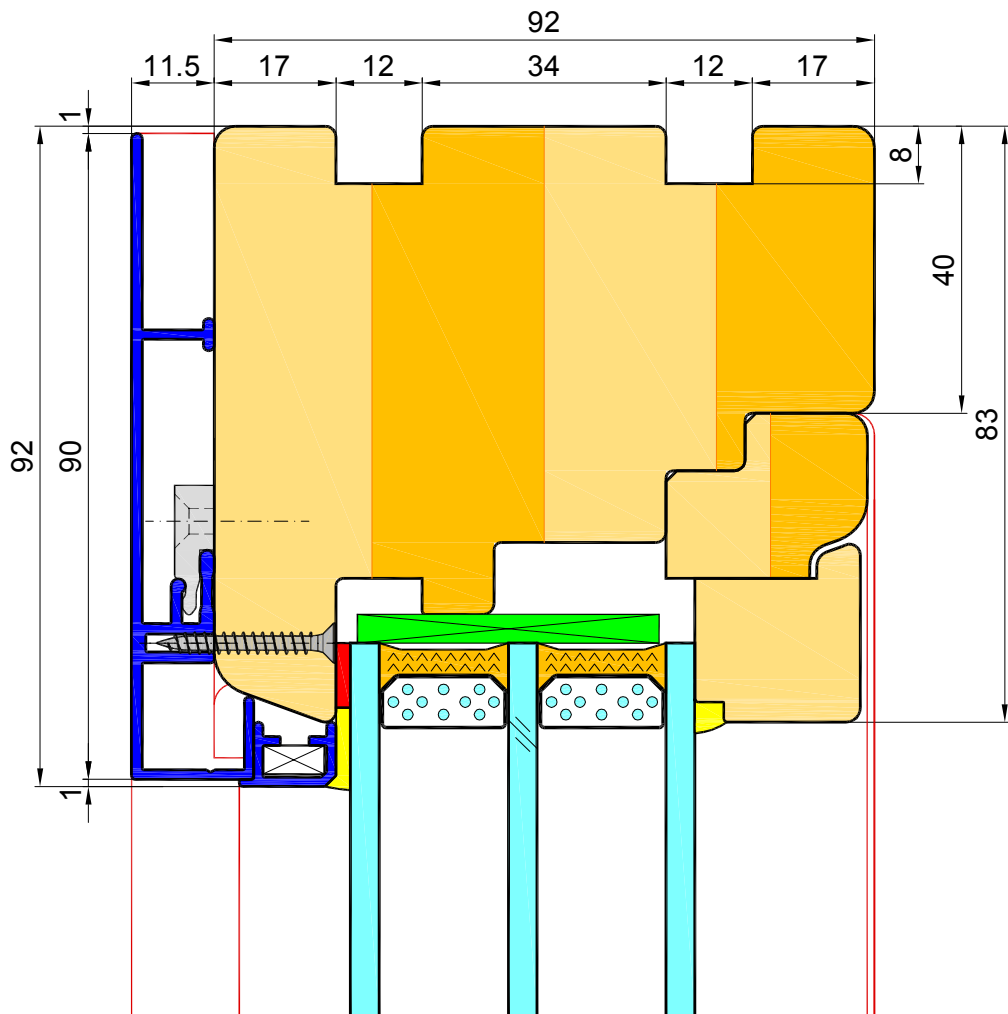

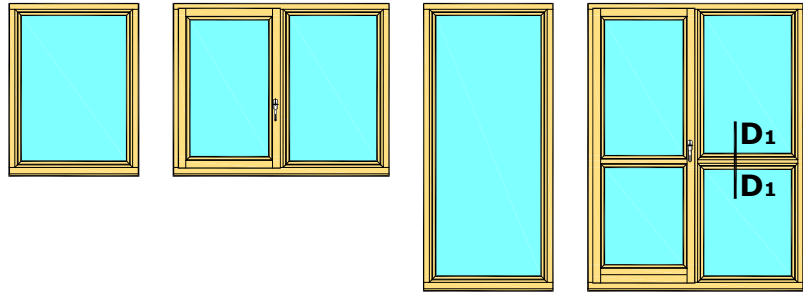

D1-D1

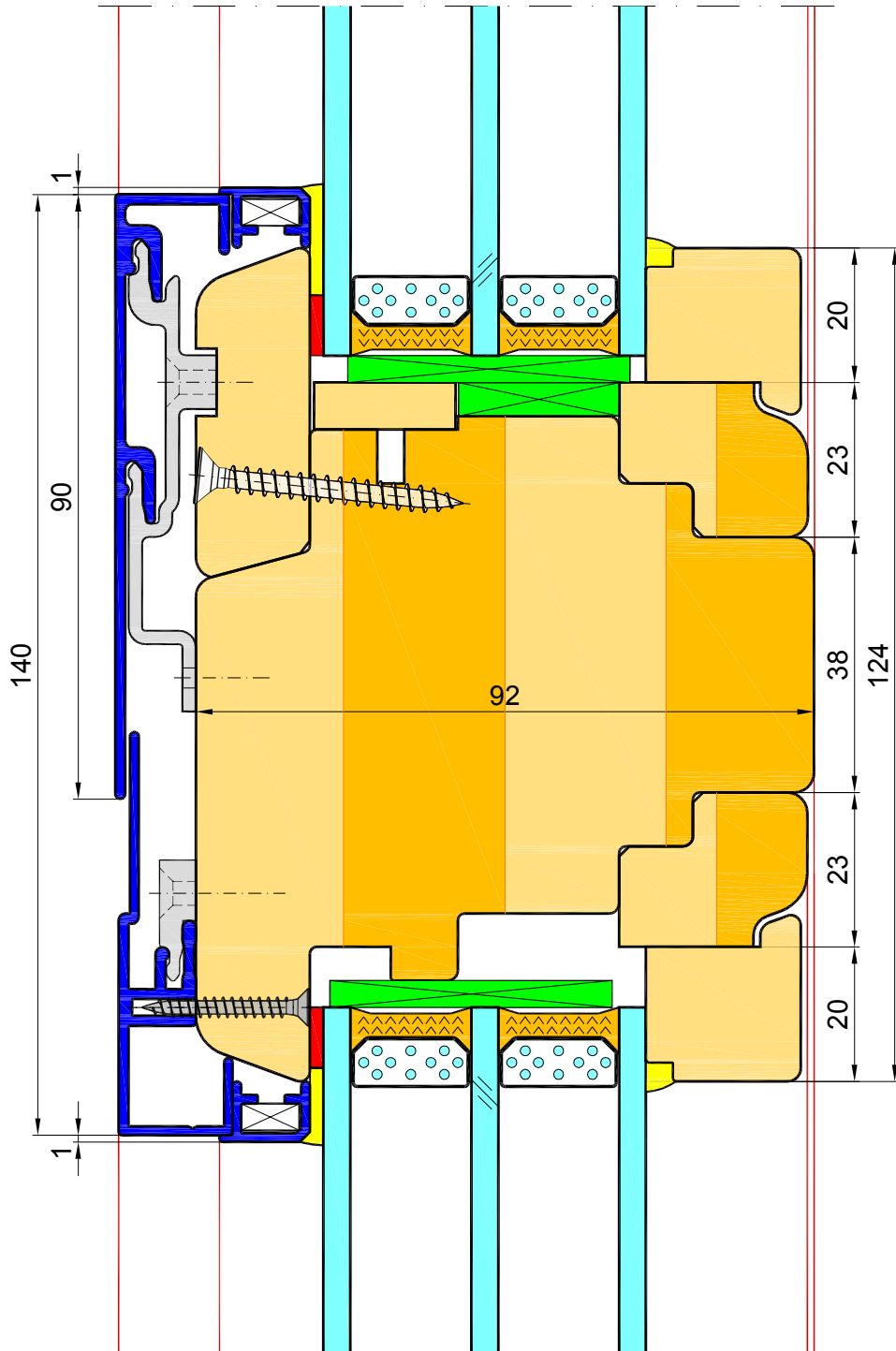

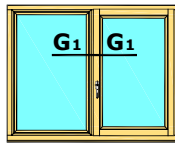
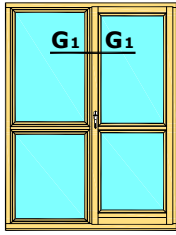

G1-G1

